



BASF

We create chemistry

Life Cycle Assessment (LCA) of Chemically Recycled Polyamide Multi-Layer Packaging

By using the example of mozzarella cheese
packaging

LCA of Chemically Recycled Polyamide Multi-Layer Packaging

Research Question

*What are the environmental impacts of the **packaging format** and the **type of raw material** in a retailed mozzarella packaging's lifecycle?*

 **BASF**
We create chemistry

 **sphera**[®]

SUDPACK

 **BASF**
We create chemistry

LCA of Chemically Recycled Polyamide Multi-Layer Packaging

Scope

Comparison of the environmental performance of a **flexible mozzarella packaging** manufactured from **chemically recycled* feedstock** in contrast to flexible mozzarella packaging solutions from fossil- or bio-based* feedstock as well as a **rigid mozzarella packaging**

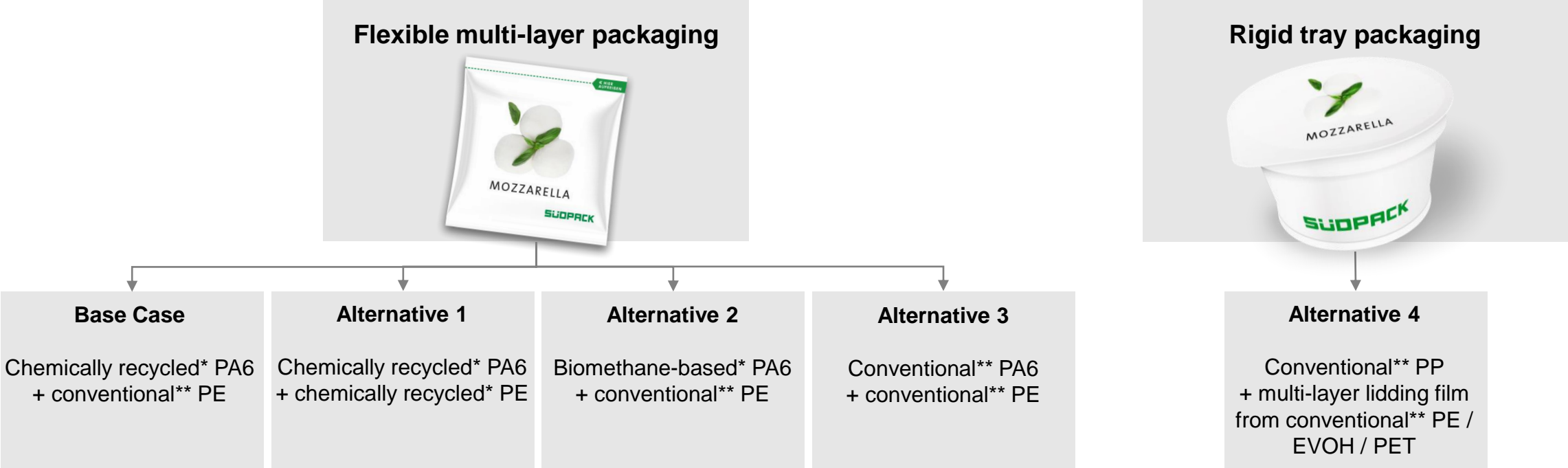

LCA of Chemically Recycled Polyamide Multi-Layer Packaging

Structure and conformity with ISO standards

Panel decision: "...this LCA study followed the guidance of and is consistent with the international standards for Life Cycle Assessment (**ISO 14040:2006 and 14044:2006**) and for Carbon Footprint of Products (**ISO 14067:2018**)"

Commissioner / LCA Practitioner

Dr. Paul Neumann

Maike Horlacher



BASF
We create chemistry

sphera

Data provided by BASF, Sphera & SÜDPACK

Critical Review Panel

Prof. Adisa Azapagic (Panel Chair)

ETHOSResearch
Environment • Technology • Society

Benedikt Kauertz

Simon Hann

ifeu
INSTITUT FÜR ENERGIE-
UND UMWELTFORSCHUNG
HEIDELBERG

eunomia

Further Information

[LCA study Website \(basf.com\)](https://www.basf.com)

[Films \(basf.com\)](https://www.basf.com)

[Ultramid® Ccycled® \(basf.com\)](https://www.basf.com)

[Ultramid® Biomass Balance \(basf.com\)](https://www.basf.com)

[Chemical recycling of plastic waste \(basf.com\)](https://www.basf.com)

[Life cycle assessment \(LCA\) for ChemCycling® \(basf.com\)](https://www.basf.com)

[Südpack: Sustainability by SÜDPACK | Climate neutrality \(suedpack.com\)](https://www.suedpack.com)

BASF
We create chemistry

LCA of Chemically Recycled Polyamide Multi-Layer Packaging

Methodical approach



LCIA methodology

Environmental Footprint (EF 3.0) assessment method published by the European Commission

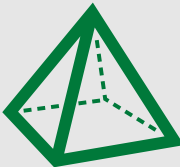

Packaging Formats



Flexible multi-layer packaging
(2.41 kg/FU)

PE: 71 %
PA: 29 %



Rigid tray + lid film
(7.25 kg/FU)

PP tray: 90 %
Lid film*: 10 %



Functional unit (FU)

Containing and providing packaging for 125 kg fresh mozzarella cheese (drained weight) contained in brine (= 1,000 packages à 125 g mozzarella)

Why Polyamides are Used in Packaging Applications?

Mechanical Performance:

- Strength, stiffness & toughness
- High puncture resistance

Product and Packagaing Processing

- Excellent thermoformability
- Heat resistance (Sterilization, Sealing)

Barrier

- High resistance and barrier to chemicals
- Medium oxygen barrier

Others

- Compliance with food contact legislations
- High quality product presentation (high transparency)



Reduction of Packaging Waste:
Downgauging at higher protection level

Economical Packaging Solutions:
Fast Processability,
Lower Cost, Performance

Food Protection:
Prevention of Food Loss

Polyamides are sustainable Packaging Components

PE/PA films are mechanically recyclable:

- Independent recyclability studies by cyclos-HTP
- PA-multilayer films are already recycled with PE flexibles (state of the art)



2022 Legal Acceptance in Germany



Appendix 3: overview of packaging groups/sorts and material-specific recycling incompatibilities

Group/sort	Incompatibilities
Film and LDPE	Fibre-based labels if the cellulose share cannot be removed by means of cold washing; PA layers (excluding nylon 6 or co-polyamide 6-66 in coextruded PE/PA films without EVOH, combined with MAH-grafted PE as an adhesive promoter at a ratio of at least 0.5 g of adhesive per 1 g of PA); PE-X components; PVDC layers; other non-PE polymeric layers (excluding adhesion promoters, adhesives, PP, EVA and EVOH), non-polymeric layers (excluding SiOx/AlOx/metallisations).



Polyamides from renewable or chemically recycled feedstocks* enable circular recycled content in food packaging:

Ultramid® Ccycled® Feedstock

- Pyrolysis oil from mixed plastic waste

Claims**

- "Closing the packaging loop"

Ultramid® BMB Feedstock

- Bio-methane from bio-circular waste

Claims**

- „Saving fossil resources by using renewable feedstock"

Virgin quality, Food contact

Certified Mass Balance

100% recycled/renewable feedstock

reduced Fossil resources

reduced CO₂ emissions



* via certified mass balance, ** all claims subject to legal assessment by user, [Multilayer packaging: innovative and sustainable \(basf.com\)](https://www.basf.com/multilayer-packaging)

Flexible Multi-Layer Packaging

From PE + PA6 (conventional or sustainable alternatives)



System Boundaries (Cradle-to-Grave):

For models containing materials from **chemically recycled feedstock** via a **mass balance approach** an **upstream system expansion via subtraction** is applied ([guideline](#) on Product Carbon Footprinting for the Chemical Industry by Together for Sustainability, 2022)

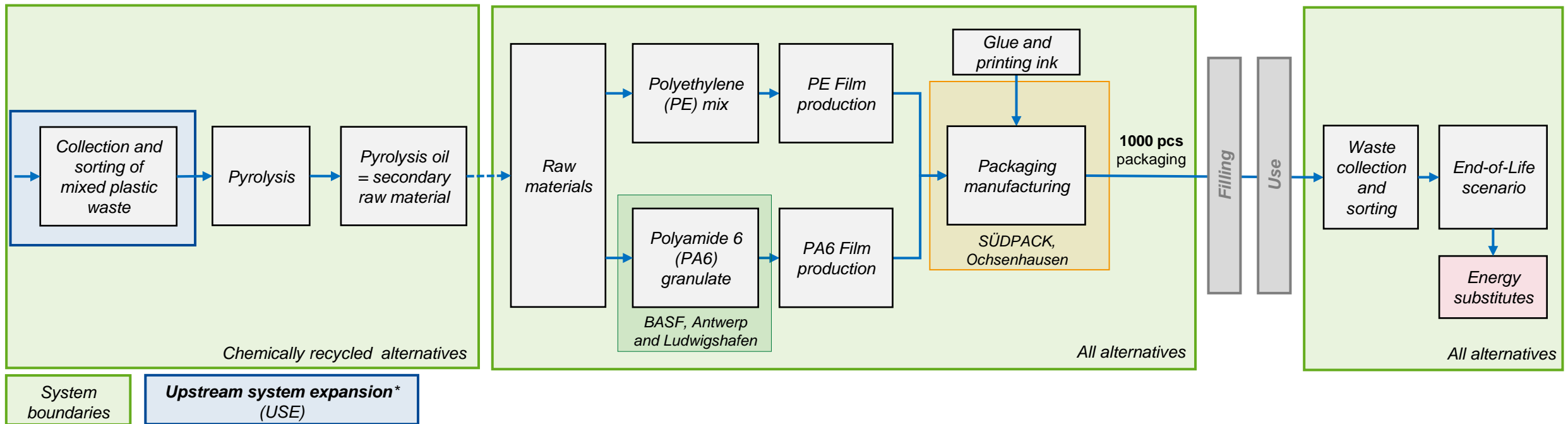

* USE (or also differential credit/burden approach) is applied whenever chemically recycled feedstock (pyrolysis oil) was employed. Activities of prevented incineration of MPW acts as a credit onto the final results whereas prevented credits for energy and electricity act as a burden onto the final results.

Rigid Tray Packaging

From conventional polypropylene (PP) + multi-layer lidding film from conventional PE / ethyl-vinyl-alcohol (EVOH) / polyethylene terephthalate (PET)



System boundaries (Cradle-to-Grave):

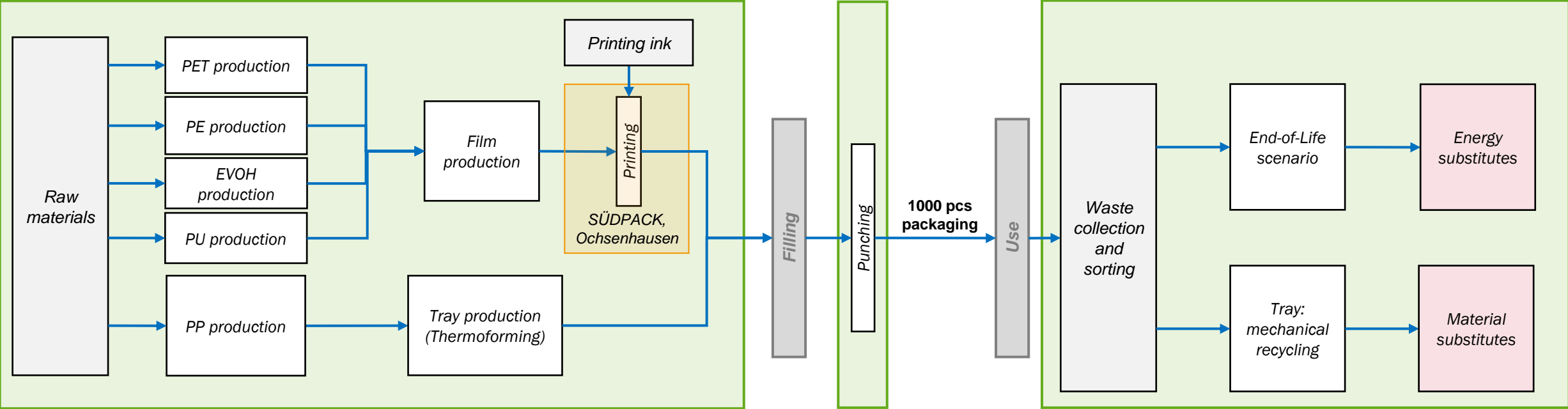

System boundaries

Contribution Analysis: Base Case

Flexible multi-layer packaging with chemically recycled* PA6 + conventional PE

The most relevant life cycle impact categories were identified, their individual contributions are illustrated based on normalization.



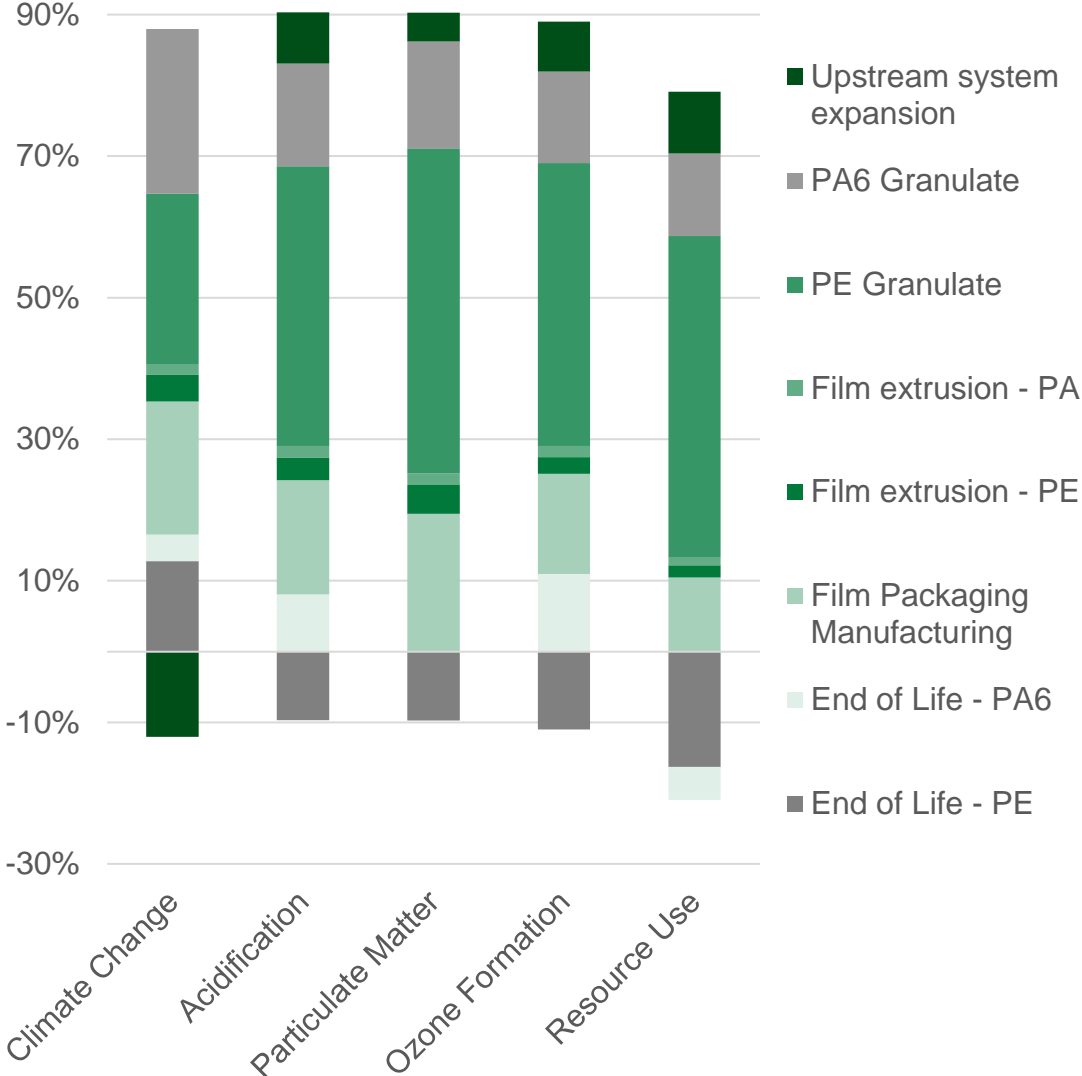

Results:

- ▶ **Polymer granulate production** steps are the most significant process steps in all examined environmental impact categories
- ▶ **Film packaging manufacturing** steps and the **upstream system expansion** contribute significantly to the selected environmental impact categories
- ▶ **Film extrusion** processes only show minor influence on all environmental impact categories



Contribution Analysis

Comparison of all examined packaging formats

Impact Category	Packaging Format	Flexible multi-layer packaging			Rigid tray	
		Base Case Chemically recycled* PA6 + conventional PE	Alternative 1 Chemically recycled* PA6 + chemically recycled* PE	Alternative 2 Biomethane-based* PA6 + conventional PE	Alternative 3 Conventional PA6 + conventional PE	Alternative 4 Conventional PP + multi-layer lidding film from conventional PE / EVOH / PET
Climate Change		0	++	0	-	--
Acidification		0	0	0	0	-
Particulate Matter		0	0	-	0	--
Ozone Formation		0	0	0	0	0
Resource Use		0	++	0	0	--

++ Very positive compared to Base Case (< -25%) -- Very negative compared to Base Case (> +25%)
 + Positive compared to Base Case (-10% - -25%) - Negative compared to Base Case (+10% - +25%)

■ **Results vs. Base Case:**

- ▶ The rigid tray (**Alternative 4**) shows very **negative impacts** in almost all categories
- ▶ **Alternative 1** is leading to **significant reductions** in Climate Change as well as Resource Use

Packaging Format Perspective

Flexible multi-layer vs. rigid tray packaging

Packaging Format Perspective

Flexible multi-layer vs. rigid tray packaging from conventional feedstock

Two retailed mozzarella packagings were compared according to their climate change impacts.



Results:

- ▶ The **rigid tray** packaging system shows the **highest potential environmental impacts in all categories**

Explanations:

- ▶ Nearly **3-fold use of raw materials** in the production of the rigid tray packaging (2.41 kg/FU for flexible vs. 7.25 kg/FU for rigid packaging)

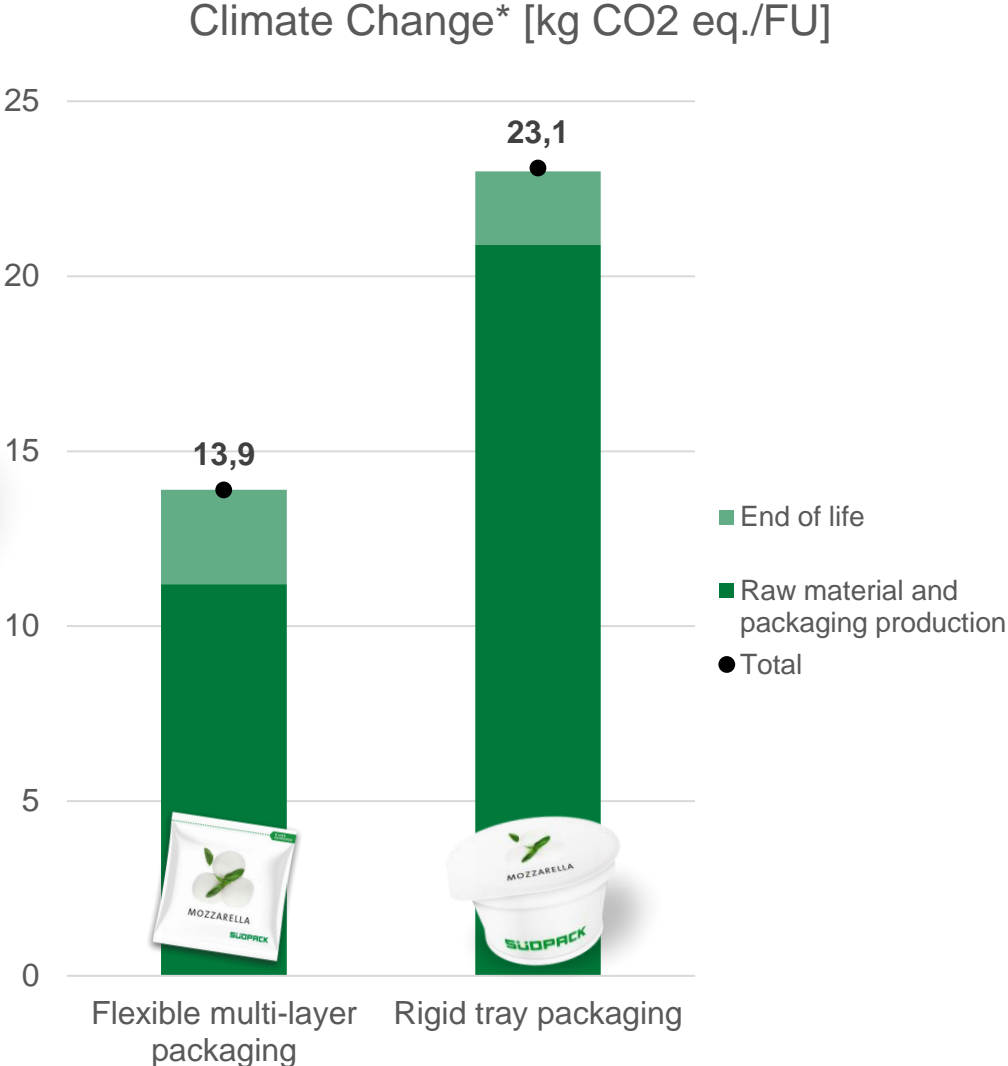

* Climate change impact category assessed based on the IPCC characterisation factors taken from the 5th Assessment Report for a 100-year timeframe (incl biogenic CO2, incl Land Use Change)

Raw Material Perspective

Flexible multi-layer packaging from conventional vs. sustainable raw materials

Raw Material Perspective

Flexible multi-layer packaging from conventional vs. sustainable raw materials

The flexible multi-layer mozzarella packaging was assessed according to the climate change impact of different raw material sources.



Results:

- ▶ The **conventional packaging** (Alternative 3) shows a significantly **higher climate change impact vs. packaging containing chemically recycled* PA6** (Base Case)
- ▶ Increasingly lower environmental impacts can be achieved using flexible multi-layer packaging with a **high share of chemically recycled* raw materials** (Alternative 1)
- ▶ **Climate change impact reductions** for packaging containing chemically recycled* raw materials are mainly **caused by the upstream system expansion**

Climate Change [kg CO2 eq./FU]

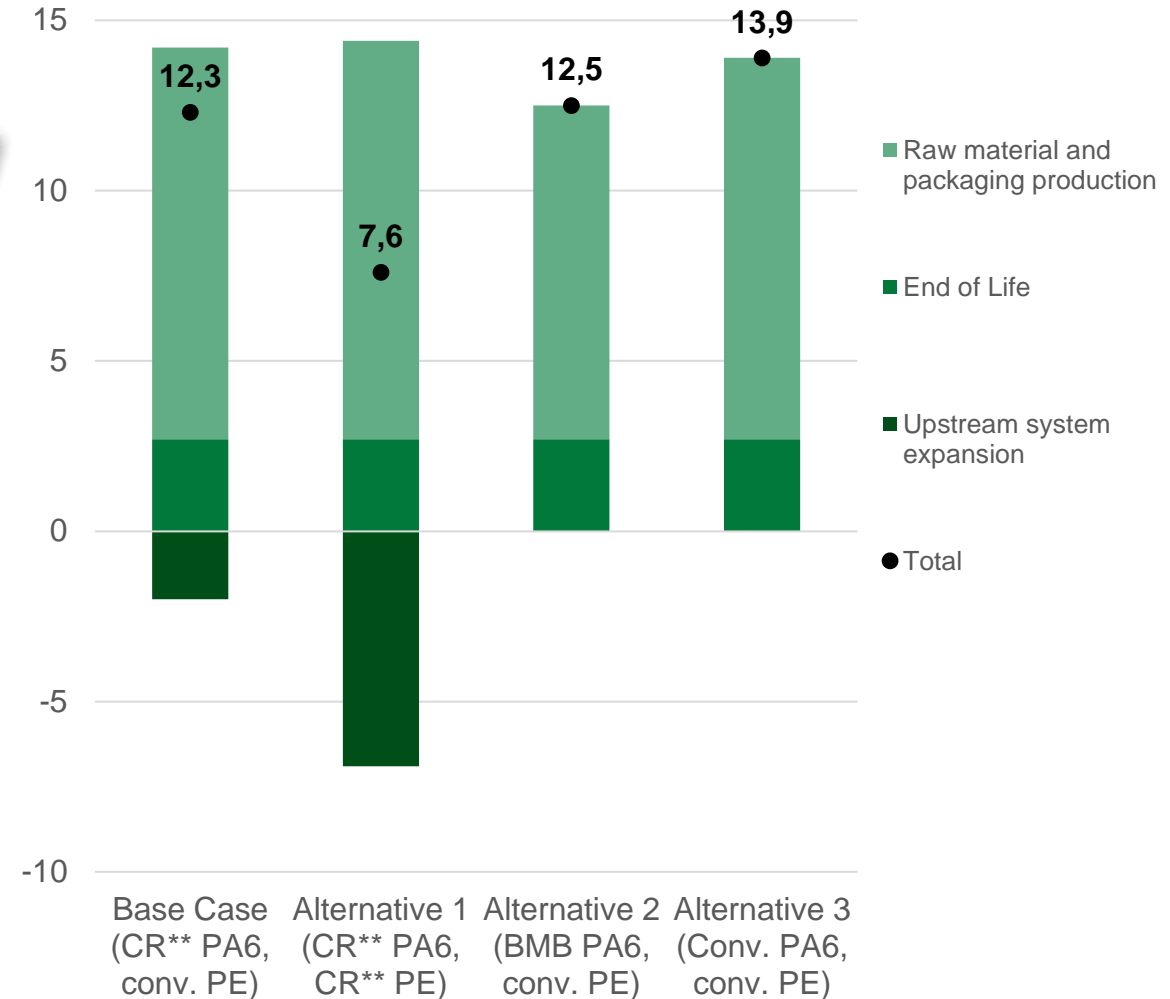

Additional scenarios

The following scenarios were analyzed for the impact category **climate change**:

Green Electricity

1. Use of green electricity for the production of PA6

Pyrolysis

2. Additional purification step in the production of pyrolysis oil
3. Optimization of pyrolysis process

End-of-Life

- 4. Chemical recycling at End-of-Life (open loop) instead of incineration**
5. Chemical recycling at End-of-Life (closed loop) instead of incineration
- 6. Mechanical recycling at End-of-Life instead of incineration**
7. 100% recycling rate of tray

Methodology

8. Cut-off-approach as End-of-Life methodology
9. System expansion by addition

Additional scenarios

Spotlight: End-of-Life

4. Chemical recycling* of multi-layer film at End-of-Life (open loop) instead of incineration

■ Results:

- ▶ **Pyrolysis** of multi-layer films **significantly reduces climate change** impacts
- ▶ **Rigid tray packaging** shows **very low climate change reduction** as the multi-layer lidding film which is subjected to pyrolysis only adds up to 10% of the overall packaging weight

Climate Change [kg CO2 eq./FU]

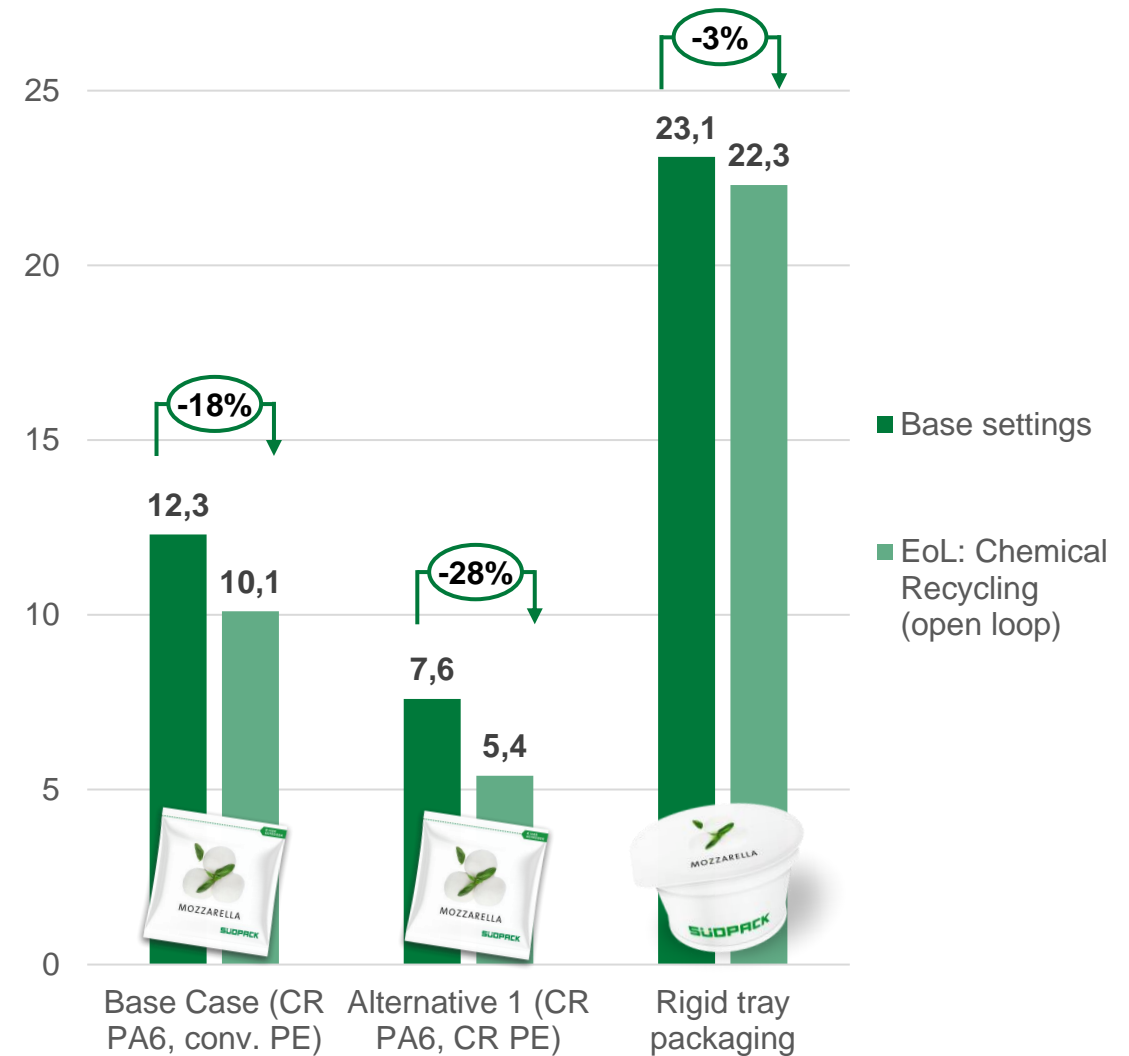

Additional scenarios

Spotlight: End-of-Life

6. Mechanical recycling of multi-layer film at End-of-Life instead of incineration

■ Results:

- ▶ **Significantly lower climate change** impacts for all **flexible packaging formats**
- ▶ In the **rigid packaging** the reduction is **not significant** because the End-of-Life scenario “mechanical recycling of multi-layer film” is applied to the **lidding film** that only makes up 10% of the overall packaging

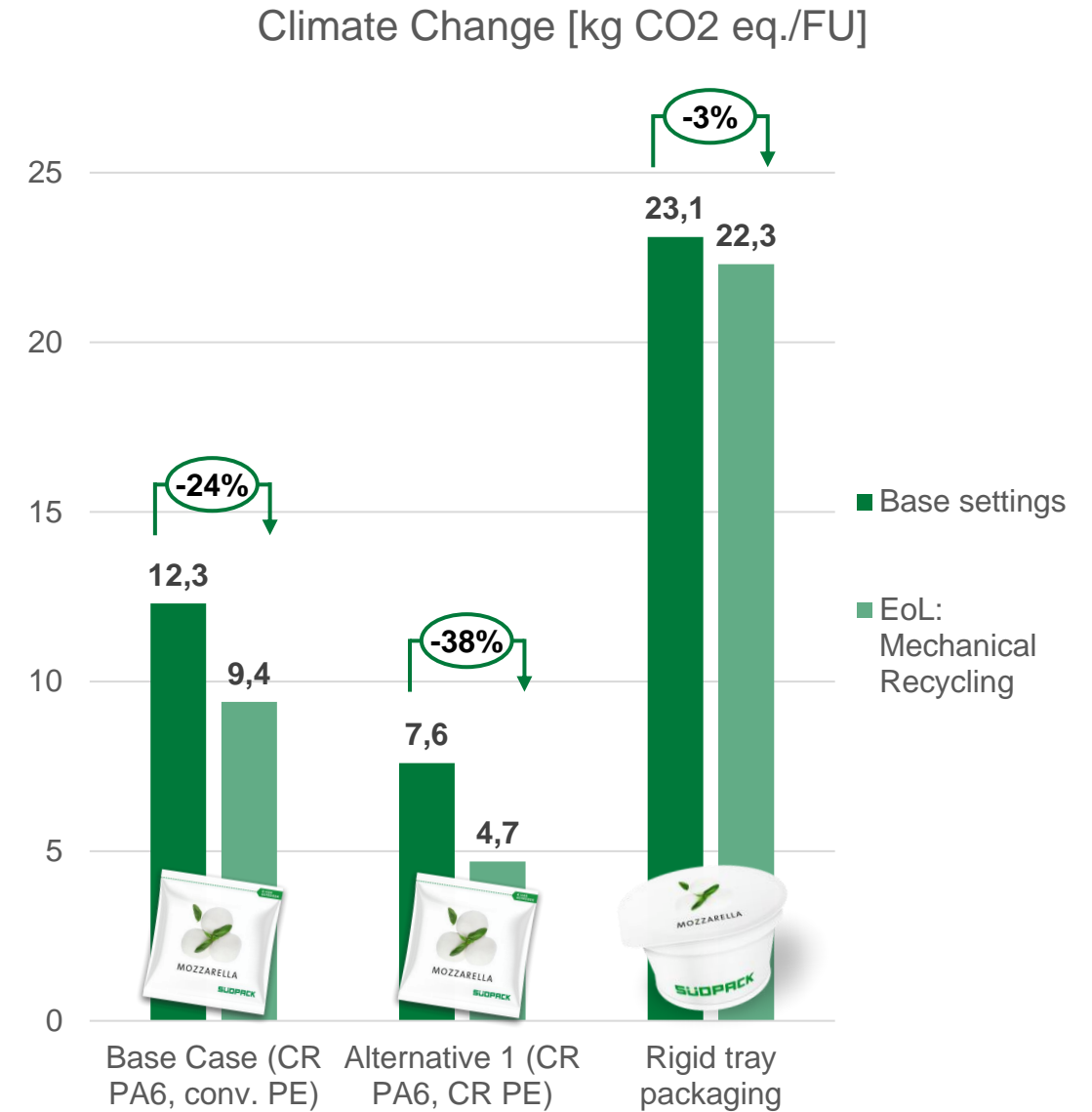



We create chemistry