

SAFE HANDLING AND STORAGE OF ACRYLIC ESTERS

THIRD EDITION

EBAM

European Basic Acrylic Monomer Group

SAFE HANDLING AND STORAGE OF ACRYLIC ESTERS

European Basic Acrylic Monomer Group (EBAM)

February 18 2015, Third Edition

Notice

The information, specification, procedures, methods and recommendations herein are presented in good faith, are believed to be accurate and reliable, but may well be incomplete and / or not applicable to all conditions or situations that may exist or occur. No representation, guarantee or warranty is made as to the accuracy, reliability or completeness of said information, specifications, procedures, methods and recommendations or that the application or use of any of the same will avoid hazards, accidents, losses, damage or injury of any kind to persons or property or that the same will not infringe patents of others or give desired results. Readers are cautioned to satisfy themselves as to the suitability of said information, specifications, procedures, methods and recommendations for the purposes intended prior to use.

Contents

| | | |
|----------|-------------------------------------------------------------------------------------|-----------|
| 1 | Introduction | 1 |
| 2 | Names, Classification and Labelling | 3 |
| 2.1 | Classification according to EU directive 1272/2008 | 3 |
| 2.2 | Transport Classifications | 5 |
| 3 | Properties and Characteristics | 7 |
| 4 | Instability and Reactivity Hazards | 9 |
| 4.1 | Polymerisation | 9 |
| 4.1.1 | Overheating causing a polymerisation | 10 |
| 4.1.2 | Photo-Initiation by UV-light and X-ray radiation causing a polymerisation | 10 |
| 4.1.3 | Contamination causing a polymerisation | 10 |
| 4.1.4 | Corrosion causing a polymerisation | 11 |
| 4.1.5 | Inhibitor Depletion causing a polymerisation | 11 |
| 4.1.6 | Inhibitor Deactivation/Oxygen Depletion causing a polymerisation | 11 |
| 4.1.7 | Polymerisation Detection | 12 |
| 4.2 | High Temperature Decomposition | 12 |
| 4.3 | Flammability and Explosive Limits for Acrylic Ester Vapours | 13 |
| 5 | Health and Safety Factors | 15 |
| 5.1 | Environmental Toxicity | 15 |
| 5.2 | Mammalian Toxicity | 15 |
| 5.3 | Industrial Hygiene | 17 |
| 5.4 | First Aid | 17 |
| 5.5 | Personal Protective Equipment (PPE) | 19 |
| 5.5.1 | Eye Protection | 19 |
| 5.5.2 | Skin Protection | 19 |
| 5.5.3 | Respiratory Protection | 20 |
| 6 | Storage of Acrylic Esters | 21 |
| 6.1 | Bulk Storage – Risk Analysis and Design Considerations | 21 |
| 6.1.1 | Detection of Critical Conditions inside Bulk Storage Tanks | 21 |
| 6.1.2 | Temperature Control of Bulk Storage Tanks and Accessories | 22 |
| 6.1.3 | Recirculation and Storage Tank Filling | 22 |
| 6.1.4 | Pumps and Protection of Pumps from Overheating | 23 |
| 6.1.5 | Emergency Venting of Bulk Storage Tanks | 24 |
| 6.2 | Storage Tank Vapour Phase | 24 |
| 6.2.1 | Tank Vent System | 24 |
| 6.2.2 | Lean Air System | 24 |
| 6.3 | Engineering Features for Environmental Protection | 25 |
| 6.4 | Engineering Considerations for Fire Control | 25 |
| 6.5 | Engineering Controls for Contamination Protection | 26 |
| 6.6 | Frequent Issues associated with the storage of Acrylic Esters | 26 |
| 6.6.1 | Avoiding Polymer Formation in Pipelines | 26 |
| 6.6.2 | Materials for Construction in Acrylic Esters Service | 26 |
| 6.6.3 | Indoor Acrylic Esters Storage Facilities | 26 |
| 6.6.4 | Commissioning and Decommissioning of Tanks | 26 |

| | | |
|-----------|--------------------------------------------------------------------------------------|-----------|
| 7 | Loading, Transport & Unloading Operations | 27 |
| 7.1 | Personal protective equipment for loading and handling | 27 |
| 7.2 | Transportation Incidents – Immediate Actions | 27 |
| 7.3 | Bulk Transport by Road and Rail | 28 |
| 7.3.1 | Information for the Haulier | 28 |
| 7.3.2 | Unloading | 28 |
| 7.4 | Drums and Intermediate Bulk Containers | 31 |
| 7.4.1 | Information for the Haulier | 31 |
| 7.4.2 | Storage of Drums and Intermediate Bulk Containers | 31 |
| 7.4.3 | Emptying of Drums and Intermediate Bulk Containers | 32 |
| 8 | Environmental Considerations | 33 |
| 8.1 | Waste Disposal | 33 |
| 8.2 | Spill and Leak Control | 33 |
| 8.3 | Air Emissions | 33 |
| 8.4 | Cleaning of Transport Vessels (Road Tankers/RTCs/IBCs) | 34 |
| 8.4.1 | Cleaning of Road Tanker / Isocontainers and Rail Tank Cars | 34 |
| 8.4.2 | Cleaning of used drums or IBCs | 34 |
| 9 | Emergency Response in Case of Polymerisation and Fire | 35 |
| 9.1 | Detection and Response to Incipient Polymerisation in a Storage Tank | 35 |
| 9.1.1 | Polymerisation Detection | 36 |
| 9.1.2 | Restabilisation (Shortstopping) | 36 |
| 9.2 | Spills | 38 |
| 9.3 | Fires | 38 |
| 9.3.1 | Firefighting Measures | 39 |
| 9.3.2 | Fire adjacent to an Acrylic Esters Storage | 39 |
| 10 | Design of Equipment for Acrylic Esters Service | 41 |
| 10.1 | Design Suggestion for a mixed gas (lean air) system | 41 |
| 10.2 | Design Suggestions for an Acrylic Esters Tank | 42 |
| 10.3 | Design Suggestions for a Scrubber | 44 |
| 10.4 | Design Suggestions for the connection of a restabilisation system | 45 |
| 10.4.1 | Schematic Design of a tank installation using mobile RESTAB™ units | 45 |
| 10.4.2 | Schematic Design of a fixed installation restablization (shortstop) system | 46 |
| 11 | Appendix | 47 |
| 11.1 | Incompatible Substances | 47 |
| 11.2 | Instructions in Writing According to ADR | 48 |
| 11.3 | Index of Abbreviations | 48 |

List of Tables

| | | |
|-----|---------------------------------------------------------------------------------|----|
| 2.1 | Acrylic Esters names, synonyms, international identification codes | 3 |
| 2.2 | Classification and labeling according to Regulation (EC) No 1272/2008 | 4 |
| 2.3 | Hazard Statements for the Acrylic Esters | 4 |
| 2.4 | Precautionary statements for the Acrylic Esters | 5 |
| 2.5 | Transport Classifications | 5 |
| 3.1 | Odour Recognition of Acrylic Esters | 7 |
| 3.2 | Properties and Characteristics of Acrylic Esters | 8 |
| 4.1 | Flammability Characteristics of Acrylic Esters | 13 |
| 5.1 | Acute Toxicity Data for Acrylic Esters | 16 |
| 5.2 | Occupational Exposure Limits OEL and Short Term Exposure Limits STEL | 17 |
| 5.3 | Glove materials and their individual breakthrough time | 19 |
| 7.1 | Recommended IBC selection for Acrylic Esters | 31 |

1 Introduction

This brochure is produced by the European Basic Acrylic Monomer Manufacturers Association (EBAM), which is a Sector Group of the European Chemical Industry Council (Cefic). Member companies are:

Arkema France

BASF SE

Dow Europe GmbH

Evonik Nutrition & Care GmbH

Hexion a.s.

Sasol Solvents (Pty) Ltd

The full text of this publication should be consulted for information on the hazards of Acrylic Esters and suggestions for its safe handling, transport and storage.

Acknowledgement: EBAM is grateful for the valuable contributions and peer reviewing of this document by the US industry organization Basic Acrylic Monomers Manufacturers Inc. **BAMM**. The member companies of **BAMM** are listed on the website of BAMM Inc. (<http://www.bamm.net>).

EBAM publishes up to date information in between of major revisions of its brochures on (http://www.petrochemistry.eu/about-petrochemistry/products.html?filter_id=7).

The purpose of this document is to provide general information to all persons who use, handle, store, transport, or may otherwise be exposed to Acrylic Esters and to advise on how to appropriately deal with the specific hazards comprising health risks, flammability, the potential for untimely polymerisations and environmental risks. Prior to working with Acrylic Esters, the extended Safety Data Sheets (SDS) should also be consulted.

Properties and characteristics contained in this document refer to Acrylic Esters with a minimum content of 99 weight-%. They conform to the specifications reported in the technical information bulletins issued by the manufacturers. Some of the physical data may be subject to minor changes, due to variable concentrations of natural impurities. Acrylic Esters are commonly stabilised with 15 parts per million (ppm) of monomethyl ether of hydroquinone (MeHQ).



2 Names, Classification and Labelling

The designation basic Acrylic Esters refers to the esters of Acrylic Esters with methanol, ethanol, n-butanol and 2-ethylhexanol. In the following table the generic names, synonyms, and international identification codes are listed.

| | Methyl acrylate | Ethyl acrylate | n-Butyl acrylate | 2-Ethylhexyl acrylate |
|----------------------------|----------------------------------------|---------------------------------------------------|-------------------------------------------------------------------------|-------------------------------------------------------------------------------------------|
| CAS name: | Methyl 2-propenoate | Ethyl 2-propenoate | n-Butyl 2-propenoate | 2-Ethylhexyl 2-propenoate |
| CAS number: | 96-33-3 | 140-88-5 | 141-32-2 | 103-11-7 |
| Synonyms: | Acrylic acid methyl ester | Acrylic acid ethyl ester | Acrylic acid n-butyl ester | Acrylic acid 2-ethylhexyl ester |
| EINECS number: | 202-500-6 | 205-438-8 | 205-480-7 | 203-080-7 |
| United Nations number: | UN1919 | UN1917 | UN2348 | no UN No. defined |
| CLP Annex VI index number: | 607-034-00-0 | 607-032-00-X | 607-062-00-3 | 607-107-00-7 |
| Chemical formula: | $\text{CH}_2=\text{CHCOO}-\text{CH}_3$ | $\text{CH}_2=\text{CHCOO}-\text{CH}_2\text{CH}_3$ | $\text{CH}_2=\text{CHCOO}-\text{CH}_2\text{CH}_2\text{CH}_2\text{CH}_3$ | $\text{CH}_2=\text{CHCOO}-\text{CH}_2\text{CH}(\text{C}_2\text{H}_5)\text{C}_4\text{H}_9$ |
| Stoichiometric formula: | $\text{C}_4\text{H}_6\text{O}_2$ | $\text{C}_5\text{H}_8\text{O}_2$ | $\text{C}_7\text{H}_{12}\text{O}_2$ | $\text{C}_{11}\text{H}_{20}\text{O}_2$ |
| Molar Mass | 86,09 | 100,12 | 128,17 | 184,28 |

Table 2.1: Acrylic Esters names, synonyms, international identification codes

2.1 Classification according to EU directive 1272/2008

Please be aware of the fact that the below mentioned classification is the status of the CLP as of the printing date of this brochure. The actual status is found in the SDS of the specific substance.

Classification

| | Methyl acrylate | Ethyl acrylate | n-Butyl acrylate | 2-Ethylhexyl acrylate |
|--------------------------------------------------|-----------------|----------------|------------------|-----------------------|
| Classification | | | | |
| Flammable liquids | Cat. 2, H225 | Cat. 2, H225 | Cat. 3, H226 | |
| Oral: Acute toxicity | Cat. 4, H302 | Cat. 3, H331 | | |
| Dermal: Acute toxicity | Cat. 4, H312 | Cat. 4, H312 | | Cat. 2, H315 |
| Inhalation: Acute toxicity | Cat. 3, H331 | Cat. 4, H302 | Cat. 4, H332 | |
| Skin irritation | Cat. 2, H315 | Cat. 2, H315 | Cat. 2, H315 | |
| Eye irritation | Cat. 2, H319 | Cat. 2, H319 | Cat. 2, H319 | |
| Specific target organ toxicity - single exposure | Cat. 3 | Cat. 3 | Cat. 3 | Cat. 3 |

table continued on the next page ...







| | Methyl acrylate | Ethyl acrylate | n-Butyl acrylate | 2-Ethylhexyl acrylate |
|--------------------------------------|-----------------------------------------------------------------------------------|-----------------------------------------------------------------------------------|-------------------------------------------------------------------------------------|-------------------------------------------------------------------------------------|
| Respiratory Tract | H335 | H335 | H335 | H335 |
| Skin sensitization | Cat. 1, H317 | Cat. 1, H317 | Cat. 1, H317 | Cat. 1, H317 |
| Chronic aquatic toxicity | Cat. 3, H412 | Cat. 3, H412 | Cat. 3, H412 | Cat. 3, H412 |
| Labelling | | | | |
| Signal word: | Danger | Danger | Warning | Warning |
| Pictogram(s) |  |  |  | |
| |  |  |  |  |
| Specific concentration limits | | | | |
| Concentration (%) | – | Skin Irr.2; H315: c>=5%; Eye Irr.2; H319: c>=5%; | – | – |

Table 2.2: Classification and labeling according to Regulation (EC) No 1272/2008

Hazard statements

| Methyl acrylate | Ethyl acrylate | n-Butyl acrylate | 2-Ethylhexyl acrylate |
|-----------------------------------------------------------|-----------------------------------------------------------|-----------------------------------------------------------|---------------------------------------------|
| H225 : Highly flammable liquid and vapour. | H225 : Highly flammable liquid and vapour. | H226 : Flammable liquid and vapour. | |
| H302 : Harmful if swallowed. | H302 : Harmful if swallowed. | | |
| H331 : Toxic if inhaled. | H331 : Toxic if inhaled. | H332 : Harmful if inhaled. | |
| H312 : Harmful in contact with skin. | H312 : Harmful in contact with skin. | | |
| H315 : Causes skin irritation. | H315 : Causes skin irritation. | H315 : Causes skin irritation. | H315 : Causes skin irritation. |
| H317 : May cause an allergic skin reaction. | H317 : May cause an allergic skin reaction. | H317 : May cause an allergic skin reaction. | H317 : May cause an allergic skin reaction. |
| H319 : Causes serious eye irritation | H319 : Causes serious eye irritation | H319 : Causes serious eye irritation. | |
| H335 : May cause respiratory irritation. | H335 : May cause respiratory irritation. | H335 : May cause respiratory irritation. | H335 : May cause respiratory irritation. |
| H412 : Harmful to aquatic life with long lasting effects. | H412 : Harmful to aquatic life with long lasting effects. | H412 : Harmful to aquatic life with long lasting effects. | |

Table 2.3: Hazard Statements for the Acrylic Esters

Precautionary statements

The below mentioned precautionary statements are not based on a specific packaging and use scenario. For a more specific compilation please consult your suppliers Safety Data Sheet.

| Methyl acrylate | Ethyl acrylate | n-Butyl acrylate | 2-Ethylhexyl acrylate |
|-----------------------------------------------------------------------------------------------------------------------------------|-----------------------------------------------------------------------------------------------------------------------------------|-----------------------------------------------------------------------------------------------------------------------------------|-------------------------------------------------------------------------------------|
| Prevention: | | | |
| P210 : Keep away from open flames/hot surfaces. - No smoking. | P210 : Keep away from heat/sparks/open flames/hot surfaces. - No smoking. | P210 : Keep away from heat/sparks/open flames/hot surfaces. - No smoking. | |
| P260 : Do not breathe gas/mist/ vapours/ spray. | P261 : Avoid breathing gas/mist/ vapours/ spray. | P261 : Avoid breathing gas/mist/ vapours/ spray. | P261 : Avoid breathing dust/fume/ gas/ mist/ vapours/ spray |
| P280 : Wear protective gloves/protective clothing/eye protection/face protection. | P280 : Wear protective gloves/protective clothing/eye protection/face protection. | P280 : Wear protective gloves/protective clothing/eye protection/face protection. | P280 : Wear protective gloves/protective clothing/ eye protection/ face protection. |
| P273 : Avoid release to the environment | | P273 : Avoid release to the environment. | |
| Response: | | | |
| P303 + P361 + P353 : IF ON SKIN (or hair): Remove/ Take off immediately all contaminated clothing. Rinse skin with water/ shower. | P303 + P361 + P353 : IF ON SKIN (or hair): Remove/ Take off immediately all contaminated clothing. Rinse skin with water/ shower. | P303 + P361 + P353 : IF ON SKIN (or hair): Remove/ Take off immediately all contaminated clothing. Rinse skin with water/ shower. | P302 + P352 : IF ON SKIN: Wash with plenty of soap and water. |
| P304 + P340 : IF INHALED: Remove victim to fresh air and keep at rest in a position comfortable for breathing. | P304 + P340 : IF INHALED: Remove victim to fresh air and keep at rest in a position comfortable for breathing. | P304 + P340 : IF INHALED: Remove victim to fresh air and keep at rest in a position comfortable for breathing. | |
| P311: Call a POISON CENTER or doctor/ physician. | P311: Call a POISON CENTER or doctor/ physician. | P311: Call a POISON CENTER or doctor/ physician. | P333 + P313 : If skin irritation or rash occurs: Get medical advice/ attention. |
| Storage: | | | |
| P403 + P233: Store in a well-ventilated place. Keep container tightly closed. | P403 + P233: Store in a well-ventilated place. Keep container tightly closed. | P403 + P233: Store in a well-ventilated place. Keep container tightly closed. | P403 + P233 : Store in a well-ventilated place. Keep container tightly closed. |

Table 2.4: Precautionary statements for the Acrylic Esters

2.2 Transport Classifications

| | Methyl acrylate | Ethyl acrylate | n-Butyl acrylate | 2-Ethylhexyl acrylate |
|--------------------------------------|-----------------------------|----------------------------|-----------------------------|-----------------------------|
| Proper Shipping name: | Methyl acrylate, STABILIZED | Ethyl acrylate, STABILIZED | Butyl acrylates, STABILIZED | – |
| ADR/RID/ADN/IMDG/IATA: | Class 3 | Class 3 | Class 3 | Not classified as dangerous |
| Packing Group: | II | II | III | – |
| United Nations No.: | UN 1919 | UN 1917 | UN 2348 | – |
| Transport hazard class: | 3 | 3 | 3 | – |
| Hazardous code ADR/RID: | No 39 | No 39 | No 39 | – |
| MARPOL Annex II pollution category : | Y | Y | Y | Y |

Table 2.5: Transport Classifications

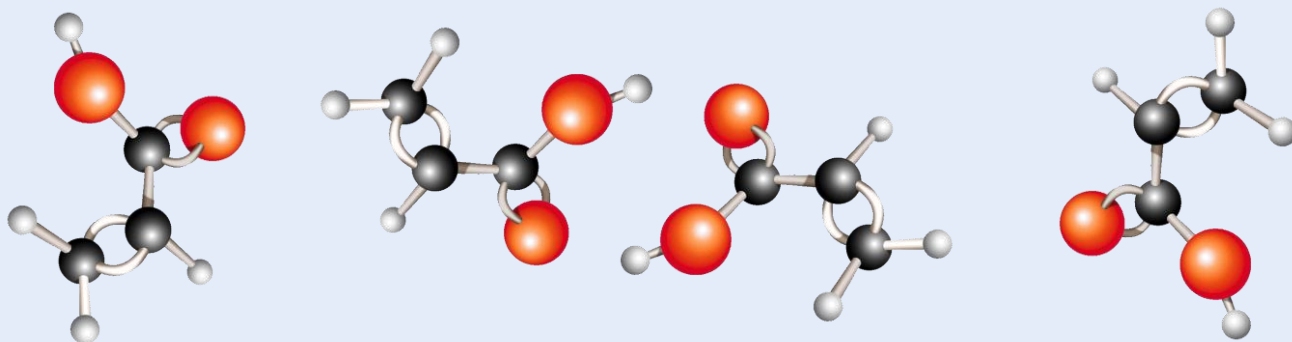

3 Properties and Characteristics

A distinctive property of all basic Acrylic Esters is their unusually low odour threshold (see the following two tables). Working with Acrylic Esters therefore requires good housekeeping practices in order to prevent odour complaints from residential and industrial neighbours. It is advisable to take the lowest number in the odour threshold ranges be used for design purposes. Care has to be taken to avoid releases, which may elicit complaints from neighbours, because of the low odour thresholds. In addition, the odour of acrylate monomers necessitates judicious selection of methods for cleaning and waste disposal (see section 8.1, page 33).

| | Methyl acrylate | Ethyl acrylate | n-Butyl acrylate | 2-Ethylhexyl acrylate |
|---------------------------------------------------------------------------------------------------------------|-------------------------------|------------------------------|------------------------------|---------------------------------|
| Odour Recognition by x% of persons | | | | |
| 50% | 3 ppb | 0,5 ppb | 0,2 ppb | 70 ppb |
| 100% | 20 ppb | 2 ppb | 1 ppb | 180 ppb |
| Odour Recognition threshold calculated as: $[\mu\text{g}/\text{m}^3] = [\text{ppm}] \times \text{MW} / 24,45$ | | | | |
| 50% | 10 $\mu\text{g} / \text{m}^3$ | 2 $\mu\text{g} / \text{m}^3$ | 1 $\mu\text{g} / \text{m}^3$ | 525 $\mu\text{g} / \text{m}^3$ |
| 100% | 70 $\mu\text{g} / \text{m}^3$ | 8 $\mu\text{g} / \text{m}^3$ | 5 $\mu\text{g} / \text{m}^3$ | 1350 $\mu\text{g} / \text{m}^3$ |

Table 3.1: Odour Recognition of Acrylic Esters

An overview of important characteristics and physical properties is given in the following table.

| Property | Condition | Methyl acrylate | Ethyl acrylate | n-Butyl acrylate | 2-Ethylhexyl acrylate | Unit | Method |
|----------------------------|------------------|-----------------|----------------|------------------|-----------------------|-------------|-----------|
| Molar mass | | 86.06 | 100.12 | 128.17 | 184.28 | g/Mol | |
| Solidification temperature | | -77 to -75 | -72 to -71 | -64.6 | -90 | °C | BS 523 |
| Boiling point | | 80 | 99 to 100 | 147 to 148 | 216 (decomposition) | °C | DIN 51751 |
| Odor | | acid | acid | sweet | pleasant | | |
| Vapour pressure | at 273 K | 30.8 | 12.0 | 1.4 | 0.02 | hPa | |
| | at 293 K | 90.5 | 39.4 | 5.44 | 0.16 | hPa | |
| | at 323 K | 340 | 168 | 28.4 | 1.33 | hPa | |
| Flash point | (closed cup) | -3 to -2 | 8 to 9 | 36 to 40 | 82 to 87 | °C | EN 22719 |
| | (open cup) | 2 to 3 | 9 to 19 | 47 to 48 | 92 | °C | |
| Explosion limit | (upper) | 19.4 (40.1)* | 9.5 (41.7)* | 8.6 (74.5)* | 6.0 (126) | Vol.-% (°C) | |
| Autoignition temperature | | 415 | 383 | 293 | 258 | °C | DIN 51794 |
| Heat of evaporation | at boiling point | 384 | 347 | 292 | 234 | kJ / kg | |
| Heat of polymerisation | | 950 | 655 | 504 | 332 | kJ / kg | |

table continued on the next page ...

| Property | Condition | Methyl acrylate | Ethyl acrylate | n-Butyl acrylate | 2-Ethylhexyl acrylate | Unit | Method |
|--------------------------------|----------------|---------------------|---------------------|----------------------|-----------------------|---------------------|------------|
| Heat of combustion | | 22504 | 25476 | 29385 | 33755 | kJ / kg | |
| Specific heat of liquid | at 293 K | 2.01 | 1.97 | 1.98 | 1.97 | kJ / kg | |
| Density of liquid | at 293 K | 0.956 | 0.923 | 0.899 | 0.886 | t / m ³ | DIN 51757 |
| Vapour density | (air = 1) | 2.9 | 3.5 | 4.4 | 6.4 | | |
| Coefficient of cubic expansion | | $1.3 \cdot 10^{-3}$ | $1.3 \cdot 10^{-3}$ | $1.15 \cdot 10^{-3}$ | $0.8 \cdot 10^{-3}$ | | |
| Refractive index nD | at 293 K | 1.402 to 1.404 | 1.404 to 1.419 | 1.415 to 1.418 | 1.434 to 1.437 | | DIN 53169 |
| Viscosity | at 273 K | 0.63 | 0.72 | 1.28 | 2.79 | mPa · s | DIN 51562 |
| | at 293 K | 0.49 | 0.57 | 0.92 | 1.82 | mPa · s | |
| Surface tension | at 293 K | 26 | 26 | 25 | 21 | mN / m | |
| Solubility | ester in water | 52000 | 15000 | 2000 | 9.6 | mg / l | OECD - GLP |
| | water in ester | 22500 | 15000 | 7000 | 15 | mg / l | |
| Electrical conductivity | | $1.1 \cdot 10^{-5}$ | $2.1 \cdot 10^{-5}$ | $1.7 \cdot 10^{-4}$ | $2.8 \cdot 10^{-3}$ | pS / m | DIN 51412 |
| Hygroscopicity | | hygroscopic | hygroscopic | hygroscopic | hygroscopic | | |
| Thermal conductivity | at 20 °C | 0.158 | 0.147 | 0.137 | 0.118 | W /m ² K | |
| | at 100 °C | 0.130 | 0.122 | 0.117 | 0.103 | W /m ² K | |

*) Average of three references:: 1: AIChE, 1985; 2: AUER Technikum, 12th edition, 1988; 3: BASF

Table 3.2: Properties and Characteristics of Acrylic Esters

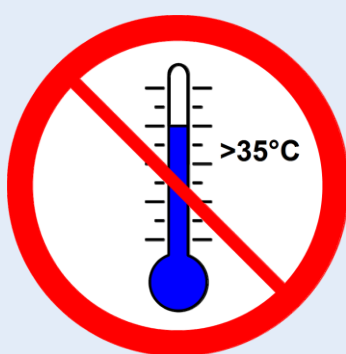

4 Instability and Reactivity Hazards

4.1 Polymerisation

One of the prevailing characteristics of Acrylic Esters is their high reactivity in the presence of free radicals. Free radicals can be generated by heat, light or irradiation of X-rays and by activation of radical forming materials.

Many substances are known to readily promote polymerisation, such as peroxides, peroxide forming and other free radical forming compounds (aldehydes, amines, azides, ethers, nitric acid). Redox-reactions of polyvalent heavy metal ions or hydrolysis of metals with strong mineral acids may likewise initiate a polymerisation. Moisture enhances the likelihood of a polymerisation.

There are six main causes of unintended polymerisation of Acrylic Esters:

- overheating (especially local overheating),
- photo-initiation,
- contamination,
- corrosion,
- inhibitor depletion, and
- inhibitor deactivation (e.g. via dissolved oxygen depletion).

Material recycled from production should never be returned to storage tanks designated for fresh monomers. If procedures for proper and safe handling are not regarded, runaway polymerisations may occur. Depending on external conditions, the polymerisation can proceed with moderate speed, or under unfavourable conditions, with increased pressure and heat release.

An explosion hazard exists also, if large clouds of vapour escape from the storage container (e.g. due to the heat of polymerisation). If the container is poorly vented, pressure build-up may occur rapidly and can lead to the rupture of the vessel. High temperatures caused by a runaway reaction can provide a serious risk of the reacting mass self-igniting. Please refer to subsection 9.1.1, page 36 for Detection and Response to Incipient Polymerisation in a Storage Tank.

Acrylic Esters are commonly stabilised with 10 to 20 ppm MeHQ (monomethyl ether of hydroquinone or p-methoxyphenol) to ensure protection from an untimely polymerisation. This stabilisation inhibitor requires oxygen to perform. This protection is only effective at moderate ambient temperatures and for handling conditions described in the following chapters. The presence of oxygen is required for the inhibitor to function.

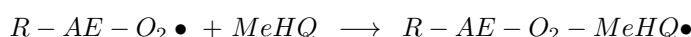
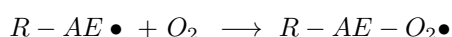
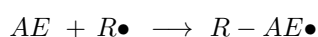

A head space containing sufficient air should always be maintained above the monomer to ensure inhibitor effectiveness.

Attention

Acrylic Esters must never be handled under an inert atmosphere due to potential oxygen depletion.

4.1.1 Overheating causing a polymerisation

Commercially available grades of Acrylic Esters have a shelf life of 1 year if properly handled. Shelf life is reduced exponentially with increasing temperature. The recommended storage temperature of Acrylic Esters is 35 °C. Testing and experience at these temperatures have shown no impact on safety, as long as shelf life is not exceeded. Overheating - especially local overheating of Acrylic Esters that may not be detected by temperature sensors - must be avoided. This may occur if:

- pumps are circulating without temperature monitoring of the circulated product,
- steam being applied to pipe surfaces accidentally or intentionally etc.

Overheating becomes especially critical if inhibitor and dissolved oxygen are not present at saturation levels in the product. Therefore the recommendation is to limit the heating medium temperature to 35 °C whilst a range of up to 45 °C may be safe if proper inhibitor levels are maintained by thoroughly mixing the product or by other means. (please refer to Inhibitor Depletion causing a polymerisation, page 11 and Inhibitor Deactivation/Oxygen Depletion causing a polymerisation , page 11.

4.1.2 Photo-Initiation by UV-light and X-ray radiation causing a polymerisation

Acrylic Esters can polymerise as a result of photo-initiation. Where sight glasses or other transparent sections are needed for visual observation in Acrylic Esters service, they should have covers to exclude light between observations. All containers such as IBC, drums, and bottles etc., used for storing Acrylic Esters should be kept from direct UV radiation.



Please note

Never expose Acrylic Esters to direct sun or UV or X-ray radiation.

There is the specific example of inspecting cargo with X-rays that can be done safely. The evaluation was done for mobile scanners with an energy dose of 0,03 mSv using a single scan. The level of X-ray energy absorbed by Acrylic Esters for such inspections, using mobile X-ray scanners, is far below the level that could alter the shelf life recommendations of Acrylic Esters.

4.1.3 Contamination causing a polymerisation

Good housekeeping must be exercised to avoid contamination of Acrylic Esters. Many compounds can promote polymerisation, such as:

- peroxides and
- compounds which form peroxides and free radicals such as azo compounds, azides, etc.
- Initiating radicals may also be formed under certain conditions from polyvalent heavy metal ions participating in redox reactions. Such metal ions include: copper, cobalt, nickel, chromium and iron.
- Nitric acid present, even in small amounts can also start polymerisation

Tanks should be protected from mistakenly being charged with other materials or from back flow from other production vessels. This can be best achieved by using dedicated loading and unloading lines with proper identification. Tanks, piping and transport vessels should be inspected periodically for polymer formation as the polymer can act as a seed for further polymerisation. Polymers of the esters are commonly soluble in the monomer. Polymer that has formed due to a contamination may cause further slow polymerisation. It can be easily detected and filtered. A list of incompatible materials is indicated in Appendix (see also Appendix 11.1, Incompatible Substances, page 47)



Please note

Dedicated lines and unloading equipment, including hoses, pumps, transfer lines etc., are the best way to avoid cross contamination with incompatible materials.

4.1.4 Corrosion causing a polymerisation

Corrosion and subsequent polymerisation initiated by metal ions cannot only be caused by improper material but also by accidental introduction of incompatible metals into the system such as gaskets, maintenance tools, carbon steel bolts and nuts (see subsection 6.6.2, page 26).

Attention

Inspect the compatibility of all construction materials with Acrylic Esters. Avoid accidental corrosion in any case.

4.1.5 Inhibitor Depletion causing a polymerisation

Inhibitors (stabilisers) are depleted with time. Elevated temperatures will accelerate this process. Observe the recommended storage time and temperature to prevent depletion of the inhibitor as well as premature depletion of oxygen (see subsection 4.1.6, page 11).

Elevated temperatures can accelerate inhibitor depletion (see subsection 4.1.1, page 10).

Attention

Observe shelf life and proper storage conditions of Acrylic Esters to avoid inhibitor depletion.

4.1.6 Inhibitor Deactivation/Oxygen Depletion causing a polymerisation

Dissolved oxygen is essential for the effective functioning of MeHQ . The inhibitor-oxygen adduct acts (is acting) as initial, and very efficient, radical scavenger. Once the dissolved oxygen is consumed, polymerisation will start.

The level of dissolved oxygen should be periodically replenished (see subsection 6.1.3, Recirculation and Storage Tank Filling, page 22 for oxygen replenishment in storage tanks and pipelines). This can be accomplished by thoroughly aerating the liquid phase, (e.g. recirculation of the inventory in tanks or agitating drums by rotating). A head space containing sufficient air should always be maintained above the monomer to ensure inhibitor effectiveness. Dissolved oxygen takes part in the inhibition reaction.

Attention

Never use an inert atmosphere above an Acrylic Ester. Make sure that oxygen is always >5 Vol.-% in the gaseous atmosphere.

Methyl acrylate and ethyl acrylate are flammable. Standard industry handling practice for non-acrylic monomer flammables is to use inert gas (nitrogen) for blowing and pigging of lines for pressure drop type level measurement devices, and for blanketing of tanks. However, the MeHQ inhibitor used in Acrylic Esters requires the presence of dissolved oxygen in the monomer.

In some applications (e.g. where tank vents are collected into a header for incineration) there may be safety concerns that prevent the use of air to blanket flammable Acrylic Esters. An appropriate safety analysis should be carried out, and applicable local regulations should be consulted. The limiting oxygen concentration (LOC) is the minimum concentration of oxygen that will propagate a flame in a gas mixture. The LOCs of methyl acrylate and ethyl acrylate are approximately 8.5 and 9.0 vol.-%, respectively. Flammable Acrylic Esters can be kept in contact with an air-nitrogen mixture containing 5 to 8 vol.-% oxygen to avoid flammability concerns during storage. Other options include the use of flame arrestors in piping connections to the storage vessel, as described in section 6.2, page 24.

An air-nitrogen mixing station can be designed to yield a gas containing a minimum of 5 Vol.-% oxygen, please refer to section 10.1, page 41. Equipment measurement tolerances must be carefully considered to ensure the operating range remains comfortably between the LOC and the minimum recommended oxygen concentration (5 Vol.-%). For example if analysis of the proposed mixing station design shows that the tolerance is $\pm 1.5\%$, then the set point of the system must be 6.5 Vol.-% in order to ensure that the oxygen concentration is always above 5 Vol.-%. The design of the mixing station should be reviewed with local safety personnel to ensure that it meets the

criterion for both protection from flammability of the material and for protection from unexpected polymerisation through all normal and emergency operations.

MeHQ will be depleted slowly over time of storage. The concentration of active MeHQ should be analysed with a chromatographic separation technique, since the photometric analytical technique does not distinguish between active and inactive quinone components.

4.1.7 Polymerisation Detection

A temperature rise that cannot be related to an external heat source should be considered an indication of a runaway polymerisation. In that event, exercise caution, but if a sample can be safely acquired, it can be used to test for the presence of soluble polymer to confirm polymerisation. While the presence of soluble polymer confirms an ongoing polymerisation, a negative result does not prove anything until all the other indicators (may include multiple samples) indicate there is no polymerisation. To test for polymer in the monomer, add 20 ml of the monomer to 80 ml of methanol. The polymer is insoluble in the methanol and the mixture will be cloudy if there is any polymer present. Occasionally on the plant scale, uncontrolled Acrylic Ester polymerisations proceed slowly. Therefore, a simple temperature rise may indicate an ongoing polymerisation. In the case of a slow temperature rise and with note of the caution below, the presence of soluble polymer in the monomer is one way to verify that a polymerisation is under way before temperature extremes are reached. See chapter 9, Emergency Response in Case of Polymerisation and Fire, page 35.

Attention

Even slow polymerisation has the potential to accelerate into a runaway reaction. If the temperature rises above 45 °C or the rate of rise is greater than 2 °C per hour, and no source of external heat has been identified, this should be considered as the onset of polymerisation. If the temperature rises at a rate greater than 5 °C per hour or the temperature reaches 50 °C, the situation is critical see chapter 9, page 35.

4.2 High Temperature Decomposition

Not all polymerisation incidents involve rapid polymerisation. Sometimes the reaction proceeds much more slowly. Still, in unvented containers or containers whose vent has plugged (note that small vents can plug easily because of slow polymerisation of condensed monomer vapours which are likely to be uninhibited), high temperatures and pressures can build up over time. If the temperature reaches 195-200 °C, Acrylic Esters will undergo degradation, e.g. decarboxylation. With a decomposition reaction, very high pressures can be generated in a vessel. Rupture of the vessel is possible.

Please note

In the event of an unintended polymerisation in a vessel, high pressures may persist long after the polymerisation event is over, because of plugging of the vent lines and the presence of decomposition gases.

4.3 Flammability and Explosive Limits for Acrylic Ester Vapours

All Acrylic Esters, with the exception of 2-Ethylhexyl Acrylate, form readily ignitable vapours at ambient temperatures. The flash points and other flammability characteristics are listed in the following table.

| | Methyl acrylate | Ethyl acrylate | n-Butyl acrylate | 2-Ethylhexyl acrylate |
|--------------------------------------|-----------------------------------------------|----------------|------------------|-----------------------|
| Flash point (closed cup) | -3 to -2 °C | 8 to 9 °C | 36 to 40 °C | 82 to 87 °C |
| Flammability limits at 25 °C in air: | | | | |
| lower limit | 2,5 Vol.% | 1,1 Vol.% | 1,3 Vol.% | 0,7 Vol.% |
| upper limit | 12,0 Vol.% | 11,8 Vol.% | 9,9 Vol.% | 8,2 Vol.% |
| Flammability categorization: | | | | |
| Flammability CLP (GHS) rating | Cat. 2, H225 | Cat. 2, H225 | Cat. 3, H226 | |
| Flammability NFPA fire rating | 3 | 3 | 2 | 2 |
| Explosion limits: | | | | |
| upper limit | 40,1 °C | 41,7 °C | 74,5 °C | 126 °C |
| lower limit | -3,8 °C | 6,4 °C | 34,9 °C | 82 °C |
| Auto ignition temperature | 415 °C | 371 °C | 293 °C | 258 °C |
| Electrical equipment NEC code | all are: CLASS I; DIV.II; Group D | | | |
| Temperature classification VDE | T2 | T2 | T3 | T3 |

Table 4.1: Flammability Characteristics of Acrylic Esters



5 Health and Safety Factors

5.1 Environmental Toxicity

The chemical category of Acrylic Esters including methyl, ethyl, n-butyl and 2-ethylhexyl Acrylic Esters have very similar environmental fate and aquatic toxicity. The Acrylic Esters are used as monomers, almost exclusively in closed systems for the production of copolymers, indicating that environmental exposure would be limited. Volatilisation to the air would predominate with any Acrylic Ester release. Furthermore, accidental releases of Acrylic Esters to the environment would not be expected to result in persistence or bioaccumulation due to their being readily biodegradable, slowly photodegradable, and relatively high water solubility. The only exception to this is 2-Ethylhexyl Acrylate, where model predictions indicate a limited potential for bioaccumulation. Available acute aquatic toxicity data for fish, aquatic invertebrates and algae indicate lethal concentration (LC) or the effect concentration (EC) to 50 % of the organisms (LC50 or EC50) values between 1-10 mg/L for the Acrylic Esters. Chronic data are limited to *Daphnia magna* where ethyl acrylate and n-butyl acrylate were demonstrated to have no observed effect concentrations (NOEC) of 0.19 and 0.136mg/L, respectively.

5.2 Mammalian Toxicity

Available data show that absorption of Acrylic Esters can occur through the skin, lungs or the gastro intestinal tract after dermal, inhalation, or oral (unlikely) exposure. Upon absorption, the esters are rapidly metabolised by normal oxidative catabolic pathways and eliminated mainly as expired carbon dioxide (45-70 %) or as conjugated metabolites in the urine (30-55 %).

Local Effects

Acrylic Esters may cause irritation to mammalian tissues and mucous membranes. Extended exposure of dermal tissue to liquid or high concentrations of vapours may result in an erythema. In rare cases blister formation has also been observed after extended exposure to liquid esters (For first aid recommendations see section 5.3, Industrial Hygiene, page 17). Inhalation of concentrated vapours and mist could produce moderate to severe irritation of the respiratory tract. High concentrations could also result in pulmonary oedema, while lower concentrations could produce nasal and throat irritation. Lachrymation from the eyes may also occur after inhalation. The vapours of the light esters have a narcotic effect and may result in drowsiness or, in severe cases, also in a loss of consciousness. Although ingestion is not an expected route of human exposure, swallowing of Acrylic Esters may cause severe irritations of the mouth, throat, oesophagus, and stomach.

Acute Toxicity

No serious health effects have been reported in humans following single exposures at low concentrations of Acrylic Esters (for exposure threshold limits see section 5.3).

Acrylic Esters produced moderate-to-pronounced toxicity following short-term inhalation exposure in laboratory animal studies, with the exception of 2-ethylhexyl acrylate where no lethality was seen up to the limit of saturation. Dermal exposure to Acrylic Esters produced no-to-low toxicity, with the exception of methyl ester which showed moderate dermal toxicity. Oral gavage exposure to Acrylic Esters in animals produced low-to-moderate toxicity with gastric irritation predominating. Ingestion is not an expected route of human exposure. The data in the following table reflect the acute toxicity data in laboratory animals.

| Acute Toxicity Endpoint | Methyl acrylate | Ethyl ¹⁾ acrylate | n-Butyl ²⁾ acrylate | 2-Ethylhexyl ²⁾ acrylate |
|----------------------------------|-----------------|------------------------------|--------------------------------|-------------------------------------------------------------|
| Oral, Rat LD50 (mg/kg bw) | 768 | 1120 | 3143 | 4435 |
| Inhalation, Rat LC 50 (mg/l, 4h) | 2.5-6.5 | 9-12.5 | 10.3 | No lethal effects at saturation concentration ³⁾ |
| Dermal, Rabbit LD50 (mg/kg bw) | 1250 | 3049 | 2000-3024 | 7522 |

¹⁾2012 IUCLID dataset.

²⁾2013 IUCLID dataset.

³⁾At the saturation concentration at ambient temperatures no lethal effects were observed in an 8-hour exposure study

Table 5.1: Acute Toxicity Data for Acrylic Esters

Skin Sensitisation

A skin sensitising effect, also known as allergic contact dermatitis, has been reported in both animals and humans for most of the esters. Specifically, ethyl, methyl, and butyl acrylate are weak sensitisers, and 2-ethylhexyl is a moderate sensitiser in laboratory animals.

Repeated Dose Toxicity

No serious health effects have been reported in humans following repeated exposures at low concentrations of Acrylic Esters (for exposure threshold limits see section 5.3). The toxicity profile following exposure to high Acrylic Ester concentrations is dominated by its local irritation effects independent of the route of application. These irritation effects were dose-dependent and include, but were not limited to, eye irritation and severe nasal degenerative effects in inhalation studies, severe stomach mucosal damage in oral gavage studies, and epidermal necrosis, dermal fibrosis, hyperkeratinosis, and dermatitis in dermal studies. The severity of these irritation effects increases during chronic exposures, resulting in atrophy, hyperplasia, and even death.

Besides the local irritation effects, effects secondary to the primary irritation effect were limited and generally included reduced body weight gain and/or organ weight effects.

Carcinogenicity, Mutagenicity and Reproductive Toxicity

Results from a number of studies are available. There is no indication that the Acrylic Esters including methyl, ethyl, n-butyl and 2-ethylhexyl Acrylic Esters are expected to be carcinogenic, mutagenic, or reproductively toxic.

All the acrylates were negative in bacterial mutation tests. For methyl, ethyl and 2-ethylhexyl acrylates, there were some clastogenic effects in mammalian cells, but the effects were only seen in doses with moderate to strong cytotoxicity. In vivo mouse micronucleus assays and chromosome aberration tests showed no mutagenic effect. Thus, none of the acrylates are considered mutagenic. There is no indication of carcinogenicity in rats or mice studies by lifetime dermal exposure or chronic drinking water administration for any of the acrylates, although IARC did list ethyl acrylate in 1986 as carcinogenic. IARC has acknowledged that the cancer classification for ethyl acrylate warrants re-evaluation. All evaluations in REACH, NTP, Health Canada, done after 1986, considered ethyl acrylate not to be carcinogenic.

There is no indication of reproductive and developmental toxic effect in animal studies with methyl, ethyl and 2-ethylhexyl acrylate, except decreases in pup body weight, which was identified to be secondary to parental toxicity. For n-butyl acrylate, no developmental toxicity or teratogenicity was observed at non-maternally toxic doses. Foetotoxic effects were seen at high maternal toxic doses in an inhalation study. Malformations were found in the presence of maternal toxicity in a high dose gavage study.

Methyl, Ethyl, n-Butyl and 2-Ethylhexyl acrylates are currently not classified as CMR.

5.3 Industrial Hygiene

Direct skin and eye contact with Acrylic Esters must be prevented. The current Occupational Exposure Limits OEL and Short Term Exposure Limits STEL are listed in the following table. Since exposure values may differ in different localities and are subject to change, check with the local authorities or with your environmental department for applicable national OEL values.

| | Methyl acrylate | Ethyl acrylate | n-Butyl acrylate | 2-Ethylhexyl acrylate |
|---------------------|-----------------|----------------|------------------|-----------------------|
| OEL (8hr TWA) | | | | |
| ppm | 5 - 10 | 5 | 2 | 5 |
| mg / m ³ | 18 - 35 | 21 | 11 | 38 |
| OEL – STEL | | | | |
| ppm | 10 | 10 | 10 | 5 |
| mg / m ³ | 36 | 42 | 53-110 | 38 |

Table 5.2: Occupational Exposure Limits OEL and Short Term Exposure Limits STEL

Acrylic Esters should only be handled in well aerated and ventilated places. If an exposure to concentrated vapours cannot be avoided (e.g. in accidents), self-contained breathing apparatus or air supply masks must be worn. Full face filter masks can be used when there is a low concentration of vapour. Care must be taken when using filter-type masks to ensure that their filter capacity is not exceeded for the intended time of use and expected concentration.

In areas where a release of Acrylic Esters is possible, eye protection, face shields, butyl rubber gloves, and rubber boots should be worn. A chemical suit with a self contained breathing apparatus is strongly recommended if larger spills or emissions have to be cleared. Appropriate protective clothing should be worn for work involving breaking or entering into a closed system containing Acrylic Esters. Due to the natural vapour pressure, the concentration of Acrylic Esters in closed rooms can far exceed the corresponding OELs.

If clothing or shoes have accidentally been contaminated with Acrylic Esters, they must be removed immediately. Contaminated leather shoes or other leather goods should be discarded. For a timely and appropriate emergency response, it is advisable to provide complete sets of safety protection equipment near places where incidents with Acrylic Esters are possible.

5.4 First Aid

In order to minimise consequences of accidents, all personnel assigned to handle Acrylic Esters must be aware that prompt and appropriate response (see following subsections) is essential. First aid must be rendered immediately. The installation of a sufficient number of emergency showers and eye washes are important for the proper management of incidents. The phone number to call for emergency medical services and all workplace specific emergency procedures should be available.

When providing first aid to a person who has been exposed to acrylates, the victim should be removed from the area to prevent further exposure. The type of exposure the person has experienced should be determined — eye or skin contact, inhalation or ingestion. If possible, do not leave an injured person alone. A co-worker should be instructed to call for help while assistance is being provided to the affected individual.

Following local regulations, if a worker working alone is exposed to acrylates, the worker should leave the area. After finding a co-worker and instructing them to call for help, the exposed worker should follow procedures to remove or dilute the contamination.

First Aid in case of eye contact

If Acrylic Esters enter the eyes, they must be cleaned with an eye wash with large amounts of lukewarm water for at least 15 minutes. The assistance of a helper is advised to make sure that all material is removed. The eyelids should be held wide open and away from the eyeballs.

Immediate assistance of an eye specialist should be sought. If a physician is not immediately available, the process of flushing the eyes with water should be continued for a second 15 minute period. Do not put any ointments or medications in a person's eyes unless specifically instructed to do so by a physician. Do not apply oil or oily ointments unless ordered by a physician.

Attention

| Do not rub the eyes.

First Aid in case of skin contact

In the event that skin contact with Acrylic Esters has occurred, all clothing should be completely removed. Washing with water under an emergency shower should be continued until all odour has disappeared from the skin. The exposed individual should be evaluated by a physician as soon as possible, due to the potential for serious harm. No ointments or medications should be applied to the skin without specific instruction from a physician.

All contaminated clothing must be appropriately de-contaminated prior to re-use. Do not take contaminated items home for laundering! If the facility is not equipped to decontaminate clothing and other items, they should be properly disposed of and replaced. Contaminated leather items cannot be adequately decontaminated and should be discarded.

Attention

| Do not take contaminated items home for laundering. Contaminated shoes must be discarded.

First Aid in case of inhalation

If a person has suffered from inhalation of Acrylic Ester vapours, remove them at once from the contaminated area and make them lie down in a well-ventilated area. They should remain there without moving. If the patient is unconscious, place them on their side in a stable position. Call a physician and ambulance immediately.

Attention

| Do not leave the person unattended.

Suggestions to Physicians

Oxygen has been found to be useful in the treatment of inhalation exposures of many chemicals, especially those capable of causing either immediate or delayed harmful effects to the lungs, such as acrylates. Any treatment should be carried out at the discretion of a physician.

In most exposures, administration of oxygen at atmospheric pressure has been found to be adequate. This is best accomplished by use of a face mask with a reservoir bag of the non-rebreathing type. Inhalation of pure oxygen (100 percent) should not exceed one hour of continuous treatment. After each hour, therapy may be interrupted. It may be reinstated as the clinical condition indicates. In the event of symptoms caused by exposure to acrylates, or in the case of a history of severe exposure, the patient may be treated with oxygen under 0,4 kPa (4 cm of water) exhalation pressure for one-half hour periods out of every hour. Treatment may be continued in this way until symptoms subside or other clinical indications for interruption appear.

It may not be advisable to administer oxygen under positive pressure in the presence of impending or existing cardiovascular failure.

First Aid in case of ingestion

Ingestion of any quantity of Acrylic Esters should be treated by having the person drink about one glass (0,2 liters) of water. See that the amount should be restricted if vomiting occurs. Vomiting can potentially cause burns to the oesophagus and other internal organs. Immediately contact local emergency medical services or the local poison control centre for assistance. The exposed

individual should be evaluated by a physician as soon as possible, due to the potential for serious harm.

Attention

Do not induce vomiting!

5.5 Personal Protective Equipment (PPE)

PPE is not an adequate substitute for technical or organisational measures such as ventilation. Nevertheless there may be situations when the only practical means of preventing employee exposure is through the effective use of PPE. Employees must be trained in the appropriate use of PPE.

PPE is available in a variety of sizes, and should fit the employee wearing it. Improperly sized and uncomfortable PPE may compromise its effectiveness and create additional safety hazards. Personal protective equipment should be selected on the basis of potential exposure via a job safety analysis.

5.5.1 Eye Protection

Splash goggles should be worn for eye protection against Acrylic Esters splashes. In addition a face shield could be worn for facial skin protection. Contact lenses are acceptable for use when worn in combination with goggles.

5.5.2 Skin Protection

Wearing chemical resistant and gas tight safety gloves over an extended period can be stressful to your skin. It requires appropriate action to protect the skin from damage or even skin diseases. It is therefore recommended to use a skin protection program covering

1. prophylactic skin protection products prior to work,
2. skin cleansing products,
3. skin care products for application after work or during breaks.

Skin protection is found in many forms: Chemical resistant gloves, protective arm sleeves, aprons, full body overalls, rubber boots, and face shields are among the types available.

The material must be impervious and resistant to Acrylic Esters.

Attention

Do not touch handles or handrails with contaminated gloves! Do not store contaminated gloves in your hard hat!

| Glove material & thickness | | Methyl acrylate | Ethyl acrylate | n-Butyl acrylate | 2-Ethylhexyl acrylate |
|----------------------------|---------|-----------------|----------------|------------------|-----------------------|
| Butyl | 0,5 mm | 202 min | – | 115 min | 274 min |
| Butyl | 0,7 mm | 274 min | 142 min | 157 min | – |
| PVC | 0,7 mm | 12 min | 16 min | 29 min | 48 min |
| FKM | 0,7 mm | 18 | 23 | 45 | 1470 |
| CR | 0,35 mm | 7 min | 8 min | 15 min | 64 min |
| NBR | 0,38 mm | 13 min | 26 min | 112 min | 566 min |

Table 5.3: Glove materials and their individual breakthrough time

Laminate gloves do not provide sufficient mechanical firmness but an excellent chemical stability. Combination of laminate glove and elastic, mechanically durable glove can overcome this risk. Butyl Rubber with 0,7 mm thickness is the recommended material in the Chemical Safety Report for the REACH dossier. Butyl rubber gloves are provided by several suppliers even with an in-liner for improved wearing comfort.

Single-use aprons and full body protection suits are available as laminate materials with breakthrough times exceeding 480 min.

Chemical resistance and breakthrough times of PPE can be different, even with identical materials. Therefore: For further information, please contact your PPE supplier.

5.5.3 Respiratory Protection

Respiratory protection is available in two basic varieties: air purifying and air supplied. Both are suitable to avoid exposure to organic vapour. Both types, however, have their particular advantages and limitations. The appropriate type of respirator must be selected to provide the best level of protection for the anticipated degree of exposure (vapour or mist) and the amount of breathable oxygen available. Air purifying respirators provide less protection than air supplied respirators but a higher flexibility. Respiratory protective equipment must be carefully maintained, inspected and cleaned. All employees required to wear respiratory protection must be medically cleared on a regular basis and trained to use the equipment.



6 Storage of Acrylic Esters

Commercially available grades of Acrylic Esters have a shelf life of up to one (1) year from production date when stored and handled under recommended conditions. A “First In First Out” principle should always be followed.

Ideally, Acrylic Esters should be stored at ambient temperature, and the recommended maximum storage temperature is 35 °C. This maximum allows time to detect and react to a potential inadvertent polymerisation.

Adequate inhibition is necessary to avoid polymerisation when storing Acrylic Esters. The standard inhibitor concentration of commercial Acrylic Esters is 10-20 ppm MeHQ. Phenolic inhibitors (stabilisers) like MeHQ require the presence of dissolved oxygen for stabilising effect.

Methyl and Ethyl acrylate readily form, and n-butyl acrylate may form flammable mixtures with air at ambient temperature. The risk of flammability can be further minimised by reducing the oxygen content in the atmosphere (to not less than 5 Vol.-%). Never use an inert atmosphere.

Retained samples can be stored up to one (1) year in a cool dark place. Amber glass bottles are recommended for handling and storing small amounts of Acrylic Esters.

6.1 Bulk Storage – Risk Analysis and Design Considerations

The design of bulk storage facilities has to be accompanied by a risk analysis using methodologies like HAZOP, or similar. The ultimate goal is to reduce the risk (risks have been outlined in chapter 4, Instability and Reactivity Hazards, page 9). This should preferably be done by detection and protection through electric and electronic devices following the IEC 61508 and IEC 61511 guidelines.

The risk has to be controlled wherever possible by appropriate design but requires the implementation of appropriate, additional procedures where automation is not feasible.

Certain incidents with Acrylic Esters resulted in situations that have caused major emissions and could potentially resulted in injuries and even fatalities. Root cause analysis stipulated the implementation of temperature recording(s) to detect an early temperature increase which might indicate a beginning polymerisation reaction with subsequent rupture of a tank or a vessel and a potential Boiling Liquid Expanding Vapour Explosion (BLEVE).

It is recommended that fail-safe positioning of automated valves and emergency backup power for critical instrumentation be included in the design. Follow all codes and regulations applicable to the geographic location of the facility. Design features of an Acrylic Esters storage facility are given in section 10.2, page 42). Contact your Acrylic Esters supplier for additional guidance.

6.1.1 Detection of Critical Conditions inside Bulk Storage Tanks

Critical conditions are typically detected by a temperature increase. A minimum of two independent temperature probes is recommended for storage tanks (check tanks, weigh vessels, and charge vessels) equipped with high temperature alarms specified by a HAZOP study.

The temperature probes should be located in the liquid phase near the bottom of the vessel (preferably 180 degrees apart on the circumference of the tank). Circulating the tank contents prevents temperature variations inside the tank (see subsection 6.1.3, page 22). The temperature signal should be recorded and monitored continuously (trend analysis) in the control room.

An inexplicable temperature increase could be an early warning sign of potentially unsafe conditions and allows leeway for corrective actions.



Attention

Start immediately to investigate an inexplicable temperature increase!
(see subsection 9.1.1, Polymerisation Detection, page 36).

Pressure relief cannot be achieved via a rupture disk in the event of a runaway polymerisation. A weak seam roof design is recommended instead. A floating roof design should not be used for Acrylic Esters storage (please refer to subsection 6.1.3, page 22 and section 4.1, page 9).

6.1.2 Temperature Control of Bulk Storage Tanks and Accessories

All storage tanks should be built in such a way that the temperature can be controlled under 35 °C. This provides sufficient time for potential emergency response if the temperature increases due to a polymerisation or fire. It may be necessary to use a heat exchanger in order to provide cooling during warmer weather and/or to remove heat generated by pumps.

Since critical conditions are typically detected by a temperature increase it is suggested in this manual to have at least three subsequent temperature alarms implemented:

35 °C as first alarm level: The temperature increase should be investigated immediately. For example check the functioning of the temperature sensors for plausibility, check the temperature increase rate, verify the temperature increase by circulating the tanks contents which should remove temperature layers. Primary countermeasure should be initiated once it is verified that the temperature increase was not caused by a malfunction or a localized temperature effect. These primary countermeasures include all the measures outlined in subsection 4.1.1 to subsection 4.1.6, page 10 ff.

45 °C as second alarm level: If no source of external heat is identified then this should be considered as the onset of polymerisation. Secondary countermeasures as outlined in section 9.1.2, page 37 should be taken.

60 °C as third alarm level: If all countermeasures to stop heatup of the tank contents are unsuccessful, then there is a possibility that the tank will rupture with a subsequent escape of an ignitable vapour cloud. Rescue measures are discussed in subsection 9.1.2, page 36 and subsection 9.3.2, page 39.

Small diameter piping systems located outdoors (including valves, pumps and filters) may experience solar heating if left liquid-full for prolonged periods of time in a static state. Potential polymer formation problems in such systems can be avoided by periodic circulation, blowing the system with a gas containing minimum 5 Vol.-% of oxygen, or by draining the system. It is also possible to reduce the risk of polymer formation problems related to solar heating by covering or insulating piping in order to prevent prolonged exposure to direct sunlight.

6.1.3 Recirculation and Storage Tank Filling

Recirculation is beneficial for mixing tank inventory, replenishing dissolved oxygen and homogeneous temperature distribution throughout the liquid phase. Submerged nozzles and pipes can plug if not frequently utilised. The dissolved oxygen content of the inventory must be maintained to keep the inhibitor working. Recirculation of the contents on a regular basis will keep adequate oxygen dissolved in the liquid as long as the gas atmosphere above the liquid level consists of a minimum of 5 Vol.-% of oxygen. A shortcut between inlet and outlet of the recirculation should be avoided e.g. by locating the fill pipe across the tank from the outlet.

A side entry nozzle is preferred equipment for recirculation. Bulk storage tanks typically have either a dip tube ending shortly above the tank bottom or a side entry nozzle near the bottom as tank inlet.

- Dip tubes are normally tack welded to the bottom to assure static grounding and have an antisiphon hole near the top.
- Side entry nozzles are usually located below the minimum liquid level of the tank in order to avoid splashing into the vapour phase and subsequent electrostatic discharges.

If side entry nozzles are equipped with an eductor for improved mixing, the nozzle must always be submerged with sufficient liquid layer when in use to avoid the possibility of forming a stable aerosol and ignition from static charge development (please consider installation in SIL 3 quality). Acrylic Esters mist caused by splashing and spraying can be ignited well below the flash point. Ensure that the inlet nozzle or eductor is submerged in liquid. It is recommended that the level monitoring instrumentation include device(s) which alarm if the tank is filled above or emptied below a safe level. The tank should be equipped with high level switches, which shut off the unloading pump before a potential spill. A minimum void volume of about 10% of blanket gas containing oxygen should be maintained above the liquid. If a differential pressure level indicator (bubbler type) is installed, a gas containing a minimum of 5 Vol.-% of oxygen must be used. Dry, oil free air is recommended for this service.

6.1.4 Pumps and Protection of Pumps from Overheating

It is highly recommended that reliable engineering safeguards, such as redundant instrument interlocks, be provided to prevent accidental overheating of Acrylic Ester pumps.

Deadheaded pumps can quickly overheat and cause a violent polymerisation (see section 4.1, page 9).

Some options to prevent overheating of pumps are:

- A flow detection element on the discharge line that activates an alarm and shutdown switch when low flow is detected.
- A temperature sensor placed inside the pump or close to the discharge which activates an alarm and shutdown switches if a high temperature is detected.
- A power monitor that senses low power consumption and activates an alarm and shutdown switch. Deadheading a centrifugal pump usually results in an immediate reduction in power consumption.
- A liquid sensor element placed in the suction line or feed vessel that activates an alarm and shutdown switch when liquid is not detected. This sensor can be used to help avoid running a pump dry but does not give deadhead protection. Centrifugal pumps quickly overheat if operated dry.

Two different types of sensors are recommended in order to provide redundant protection from pump overheating.

Other considerations associated with pumping Acrylic Esters are given below:

- Double mechanical seal and magnetic drive centrifugal pumps are commonly used for Acrylic Ester service. They can reduce fugitive emissions and the risk of spills. Double mechanical seals are commercially available using a liquid (such as a glycol) or a gas (such as oil free air) as the barrier fluid. These pumps require instrument interlocks to prevent dangerous overheating in case deadheading accidentally occurs.
- Air driven diaphragm pumps are occasionally used for acrylate service. Diaphragm pumps usually stop pumping if deadheaded and may not require instrument interlocks to protect against overheating.
- Seals and bearings in contact with Acrylic Esters should be flushed for adequate cooling and lubrication. High surface temperatures can cause polymer particles to form.
- Pump seals/glands, flanged fittings, and valve stems should always be provided with splash collars.
- Truck mounted pumps should not to be used for unloading Acrylic Esters because of the potential for contamination, leaks and overheating.

Your supplier may be contacted for additional guidance on the selection and safety of Acrylic Ester pumps.

6.1.5 Emergency Venting of Bulk Storage Tanks

It is common practice to design the capacity of a tank emergency vent system based on the vapours generated by a pool fire. Relief valves, weighted pallets, quick release man way covers and rupture disks can all be used to vent vapours generated by a pool fire. If used, an open vent can be sized for the pool fire case.



Please note

There is no known method for reliably relieving pressure from a run-away polymerisation of Acrylic Esters in a tank.

It is suggested to use weak seam roofs in order to provide maximum venting in case of an inadvertent, strongly exothermal polymerisation. Roof guide cables should be considered to control the trajectory of such a roof.

Emergency vent devices should be inspected at least once a year to ensure functionality. Potential polymer build-up must be removed. For more information please refer to section 4.1, Polymerisation, page 9 and subsection 9.1.2, Restabilisation (Shortstopping), page 36.

Emergency vents from indoor storage tanks should be routed to the outside. Contact your supplier for additional guidance.

6.2 Storage Tank Vapour Phase

6.2.1 Tank Vent System

Typically the maximum tank level allows for 10% void volume. This provides adequate oxygen containing gas to keep the MeHQ inhibitor activated. The storage tank should be connected to an off-gas treatment system. Off-gas treatment can either be done through scrubbers, incinerators, or thermal oxidation units. Local, state, and federal regulations may apply. Contact your supplier for additional guidance.

A combination pressure-vacuum relief valve (PRV), sometimes referred to as conservation vent valve, is frequently employed to help minimize the multiplicity of equipment and nozzles. The size and output of the feed pumps must be adapted to the venting capacity. It is recommended to have an emergency PRV with a higher positive setpoint installed in addition to a standard PRV valve. Precautions should be taken to minimize condensation of Acrylic Esters in vent nozzles and lines. Acrylic Esters condensed from vapour do not contain MeHQ stabiliser and are prone to form polymer. Polymer can plug critical pressure and vacuum relief lines. Slope vent lines to drain condensed liquid back to a vessel and provide liquid drains where stagnant Acrylic Esters may occur. Polymer formation is likely in stagnant pockets.

It is suggested that vapour return lines be installed to reduce emissions during unloading or loading of transport vessels such as rail cars or tank trucks. These lines should be kept free of polymer and the vent conservation valves should be correctly adjusted so that Acrylic Ester vapours during unloading and loading are contained.

The need to install flame arresters in vent lines may depend on the Acrylic Ester to be stored and the applicable regulations and codes of a given region, as well as the flash point of the acrylate and the flammability of the tank vapour phase. Routine inspections of the conservation vent system and the flame arrestors are recommended. This is to ensure effective functioning and to remove any polymer.

6.2.2 Lean Air System

MeHQ requires the presence of dissolved oxygen for stabilisation. To support inhibition, a minimum of 5 Vol.-% oxygen in the gaseous atmosphere is recommended. Methyl and ethyl acrylates readily form, and n-butyl acrylate may form flammable mixtures with air at ambient temperature. To address flammability concerns while maintaining the necessary oxygen for inhibition, a mixture of air and nitrogen may be employed. Oxygen concentration levels below LOC (Limiting Oxygen Concentration) ensure that there is no flammable atmosphere in the tank vapour phase. The LOC of methyl acrylate, ethyl acrylate and n-butyl acrylate are approximately 8.5, 9 and 9.5 Vol.-% respectively.

An air-nitrogen mixing station can be designed to yield a gas containing a minimum of 5 Vol.-% oxygen. Equipment measurement tolerances must be carefully considered to ensure the

operating range remains comfortably between the LOC and the minimum recommended oxygen concentration (5 Vol.-%). For example if analysis of the proposed mixing station design shows that the tolerance is $\pm 1.5\%$, then the setpoint of the system must be 6.5 Vol.-% in order to ensure that the oxygen concentration is always above 5 Vol.-%. The design of the mixing station should be reviewed with local safety personnel to ensure that it meets the criterion for both protection from flammability of the material and for protection from unexpected polymerisation through all normal and emergency operations depending on the application and desired safeguards. An air-nitrogen mixing station can be designed as shown in section 10.1, page 41.

Attention

Never use an inert atmosphere when storing or handling Acrylic Esters. Make sure that oxygen is always > 5 Vol.-% in the gaseous atmosphere.
(see subsection 4.1.6, page 11 and section 11.1, page 47).

6.3 Engineering Features for Environmental Protection

Spill containment helps to protect public waterways and ground water. Dikes around storage tanks are used to contain spills. The size of the diked area should hold the volume of the largest tank. Concrete is typically used as construction material. Make sure that the material used for containment is compatible with Acrylic Esters. Spill containment for bulk unloading areas will reduce environmental risks. Concrete containment is suggested for bulk unloading areas. Instrumentation to monitor the liquid level in bulk storage tanks should be installed to prevent spills (see subsection 6.1.5, page 24). It is good practice to have both a level switch and a continuous level measurement device installed. High level alarms and interlocks should be implemented. Vapour return lines are suggested for bulk unloading facilities to reduce emissions (see section 6.2, page 24). For low emission pump design, please refer to subsection 6.1.4, page 23.

6.4 Engineering Considerations for Fire Control

All Acrylic Esters with the exception of 2-Ethylhexyl acrylate form readily ignitable vapours at ambient temperatures. The flash points and other flammability characteristics are listed in section 4.3, page 13 in the corresponding table. When oxygen is present above the LOC, ignition may occur in the presence of ignition sources. Besides common sources of ignition, spark discharge from static electricity or improperly grounded and bonded vessels should be investigated.

Acrylic Esters flowing through or being discharged from a pipeline may generate static electricity. Hence, during transfer from one container into another these should be electrically interconnected (bonded) and properly grounded. Splashing into a tank should be avoided by the use of a dip tube. If mixing nozzles are used in storage tanks (see subsection 6.1.3, page 22), care should be taken to keep the nozzles always well below the liquid surface to avoid spraying. All permanent storage tanks that contain Acrylic Esters with low flash points are required to be fitted with the legally obligatory fire protection equipment. Outlets to the atmosphere must be protected with flame arrestors and detonation traps. For detailed information see section 6.2, page 24.

Exhaust gases loaded with Acrylic Esters are best purified in a wet scrubber using ordinary caustic, aqueous organic amines or a mixture of both (see section 10.3, page 44). For the final off gas purification, an activated carbon cartridge can be used. The heat of absorption for all acrylic monomers on activated carbon is unusually high. Therefore if highly loaded exhaust gases are passed over activated carbon, ignition of the carbon bed may occur. Active carbon cartridges must never be used for the removal of Acrylic Esters from exhaust gases, unless the gases are pre-treated in a wet scrubber. For the prevention of flame flashback into the tank, carbon cartridges must always be separated from the tank by a flame arrestor.

However, if a fire occurs in or close to a tank farm containing acrylic monomers, tanks and pipes should be cooled by spraying with plenty of water in order to prevent monomers from polymerising. A restabilisation (shortstopping) system can be installed to allow the quick addition of phenothiazine (PTZ) in the event of a fire. Acrylic Esters containing PTZ are much less likely to polymerise violently during a fire (see subsection 9.1.2, page 36).

Small fires can be fought with carbon dioxide or dry chemical extinguishers. For larger fires, foam is suitable. All esters are immiscible with water and lower in density than water. Consequently, water will not adequately extinguish a fire. A foam system with injection nozzles can be used to extinguish an Acrylic Esters fire.

6.5 Engineering Controls for Contamination Protection

The unloading pump should be equipped with a dedicated unloading hose. Best practices preventing back-flow of liquids have to be followed, e.g. check valves in the filling line, automated devices to prevent siphoning from other equipment back into the storage tank.

The venting system should be designed such that backflow of gases from other tanks vent is avoided, e.g. using PC-valves.



Please note

It is essential to avoid by any means the accidental entry of incompatible substances into an Acrylic Esters storage tank either via liquid lines or via the vent system.

6.6 Frequent Issues associated with the storage of Acrylic Esters

6.6.1 Avoiding Polymer Formation in Pipelines

Empty and drain liquid filled pipelines or replenish oxygen by occasional circulation or clearing the lines with lean air (no inert gas! See subsection 4.1.6, page 11). Residues in transfer lines and other stagnant areas should be blown out. It is preferred that transfer lines be designed to be self-draining.



Attention

Do not to leave stagnant lines or nozzles liquid-full for more than 4 weeks.

6.6.2 Materials for Construction in Acrylic Esters Service

Proper choice of materials of construction is important for safety, health, and protection of the environment. Some specific guidance for Acrylic Esters service is given below. Contact your supplier for further information.

- The preferred construction material for tanks and pipes is stainless steel. Carbon steel is also acceptable, although the formation of rust may be a problem with product quality (colour). Iron ions (Fe^{3+}) have been shown to be a weak polymerisation initiator. If carbon steel is to be used, special procedures should be used to prepare the tank for use. Contact your supplier in such a case.
- Preferred gaskets are made of PTFE, cross- linked EPDM, stainless steel with graphite coating or Kalrez[®] and specified according to the local emissions regulations.

6.6.3 Indoor Acrylic Esters Storage Facilities

Indoor Acrylic Esters storage facilities should be well ventilated to prevent local accumulation of vapours in case of a leakage or during maintenance work. It must be noted that using fresh air for ventilation could cause freezing problems during the cold season. It is suggested that adequate air change rates be ensured. Nevertheless for special work e.g. maintenance it is recommended local exhaust systems be considered to supplement the general exhaust system. All indoor bulk storage tanks should have their emergency vent system outside of the building and the regular venting should be connected to an off-gas treatment system.

When Acrylic Esters are handled indoors, e.g. drumming, fumes should be withdrawn by suction from the workplace.

6.6.4 Commissioning and Decommissioning of Tanks

If information is needed, contact your supplier.



7 Loading, Transport & Unloading Operations

The following, general considerations apply to all modes of transportation for Acrylic Esters (See chapter 4, Instability and Reactivity Hazards, page 9).

- Acrylic Esters must be transported and handled under an atmosphere containing at minimum of 5Vol-% oxygen. The MeHQ stabiliser is not effective in the absence of oxygen (See subsection 4.1.5, page 11).
- Do not use pure nitrogen or other inert gases for unloading, blowing lines, or blanketing. Pure nitrogen or other oxygen-free gases will reduce the amount of dissolved oxygen. The effectiveness of the inhibitor/stabiliser might be significantly reduced, resulting in a hazardous situation.
- Cleanliness and good housekeeping is essential. All containers must be free of contamination. The incompatible materials list (Appendix 11.1, page 47) should be followed. Please refer to section 8.4, page 34 for the Cleaning of Transport Vessels.
- Avoid overheating of Acrylic Esters by adjacent cargo in multi-compartment vessels. It should be ensured that the resulting maximum product temperature does not exceed 35 °C.
- Under no circumstances should steam be used to clean a tank with Acrylic Esters or to heat Acrylic Esters.
- Most Acrylic Esters are classified as "flammable liquids" as defined in the transport regulations (please refer to section 4.3, page 13). As such, Acrylic Esters must be packed in specific containers when shipped.
- EBAM suppliers adhere to all regulations concerning free air space in filled containers. This corresponds to a minimum void space of 7 Vol-% at 25 °C.
- Retained samples should be stored for no more than one year in a cool dark place.

7.1 Personal protective equipment for loading and handling

Industrial hygiene exposure limits should be considered when selecting proper respiratory protection. Full protective clothing should be considered as proposed by the suppliers following the local regulations. Contact lenses substantially increase the risk of damage to eyes and, if your policies permit, should only be worn with special precautions. Full eye protection should include plastic shields with forehead protection in addition to chemical splash goggles (see section 5.5, page 19 for further information).

7.2 Transportation Incidents – Immediate Actions

If a delivery cannot proceed safely due to damage of the shipping container [rail car, tank truck, drum, intermediate bulk container (IBC)] or its content, then every effort should be made to move the container to a vicinity where it will not endanger traffic or property. If possible, the container should be moved to a vacant area away from populated areas. The local police and fire departments should be notified and the public should be restricted from the area. Follow

precautions stipulated in the supplier's SDS for Acrylic Esters. See chapter 9, Emergency Response in Case of Polymerisation and Fire, page 35 for additional information.

Please note

For further technical assistance consult the supplier immediately by calling the following emergency response telephone numbers

| | |
|------------------------------|---------------------|
| Arkema France | +33 (0)3 87 93 8500 |
| BASF SE | +49 180 2273 112 |
| Dow Europe GmbH | +31 11 5694982 |
| Evonik Nutrition & Care GmbH | +49 2365 49 22 32 |
| Hexion a.s. | +420 352 614222 |
| SASOL Chemie GmbH & Co KG | +44 208 762 8322 |

7.3 Bulk Transport by Road and Rail

The bulk transport of Acrylic Esters, either by tank truck, rail car or iso container is authorised by ADR/RID and IMDG. Please consult these and/or local regulations for complete and up-to-date specifications and labelling requirements. In some climates the transport vessels should be insulated in order to maintain product temperature below 35 °C.

7.3.1 Information for the Haulier

The haulier is responsible for providing transportation units that meet all guidelines for safe transport of Acrylic Esters and maintain the recommended product temperature during shipping.

The temperature of the empty vessel should be less than 35 °C before loading with an Acrylic Ester. Drivers should be thoroughly trained about the hazards of Acrylic Esters. To ensure reliable operation, the temperatures of product should be monitored. In transit, the driver should log the temperature of the Acrylic Ester once every 8 hours until the delivery is made. The customer should be shown this log at the time of delivery.

Attention

Temperatures >35 °C can be hazardous and the root cause has to be investigated. If the temperature is confirmed e.g. via a second temperature measurement, preferably a dip probe to have reached 35 °C and higher, immediately contact the supplier (see section 7.2, page 27).

Such high temperatures may be a warning sign of a possible inadvertent polymerisation and must be investigated. The vessel should be isolated as dictated by the circumstances and conditions at the time (see chapter 4, page 9 on instability and reactivity hazards and chapter 9, page 35 on emergency response). If non-dedicated transport vessels are used, it becomes imperative that a certificate of cleanliness indicating the previous cargo be presented before starting the loading operation (see section 8.4, page 34 and Appendix 11.1, page 47).

7.3.2 Unloading

The following procedures are suggested to reduce quality and safety risks during the unloading of Acrylic Esters. The contents of the vessel must be positively identified before they are transferred. Sampling and analysis are considered as appropriate measures for product qualification. Continuous monitoring of the entire unloading process is recommended. Acrylic Esters are flammable liquids and should be handled accordingly.

An emergency shower and eye wash station should be directly accessible from the unloading area. The emergency shower and eye wash station should be tested periodically to ensure that they function properly. Personal protective equipment should be worn while sampling or making any connections.

Proper equipment should be used to protect against spills. It is preferable that truck unloading facilities be level, paved and be located so that the truck can be easily and safely manoeuvred. A place should be provided with a truck pad suitable to collect spillages for salvage or appropriate disposal. Where access to the top of the container is needed, the site should be equipped with stairs and a platform.

An electrical grounding cable is required and must be attached to the transport vessel while loading or unloading the container.

The piping used for unloading should be on continuous circulation or arranged so the Acrylic Ester will drain toward the storage tank when transfer is stopped. Where necessary, a check valve should be provided on the unloading hose to ensure that total tank contents will not spill in the event of a hose break. Dedicated hoses at the unloading site should be used to avoid contamination. These hoses usually are better maintained and thereby minimize also the risk of spills. Dry disconnect couplings are recommended to be provided on the unloading hose to reduce the amount of fugitive emissions during coupling and uncoupling operations. Alternatives to this procedure include employing a vacuum clean out system or flushing out hoses and lines with water or blowing them empty by lean air. The vacuum clean out can even be conducted while disconnecting the hoses and thereby efficiently minimizes odours. The pump glands, flanged fittings and valve stems should be provided with splash collars in cases where personnel could be exposed to major Acrylic Esters leaks or sprays. Acrylic Esters should be unloaded using a vapour return line in order to limit emissions to the environment. The vapour return line is recommended to be a standard connector.

Unloading Trucks and Isocontainers

The suggested unloading procedure is by pumping with a closed loop (vapour balance) system in which the vapours are returned to the vessel. If this system is not possible, the vapours should be sent to a scrubber or incinerator.

1. Spot the transport unit and set wheel chocks. Stop the engine and apply the emergency breaks during unloading.
2. Positively identify Acrylic Esters. Before unloading, inspect the vessel to ensure that it is not damaged or leaking. Compare the labels and the vessel identification number to ensure that they are identical to the transport documents.
3. The transport unit must be properly grounded before proceeding with any other operation.
4. Check that the vessel inventory is less than 35 °C before unloading. **If the temperature of the Acrylic Esters is confirmed to be above 35 °C immediately contact your supplier.**
5. Verify that the receiving vessel or tank will hold the entire contents of the tank truck or iso container.
6. Connect the vapour hose and open the valves to equalize pressure.
7. Remove the protection cap of the coupling. Be aware: in case of dripping bottom and outlet valves Acrylic Esters contact is possible when removing the protection cap!
8. Ensure that the unloading liquid line is connected to the Acrylic Esters storage.
9. Connect the liquid line and open the external valve.
10. Open the internal valve.
11. Start the pump. Once the flow has started, continue to monitor the vapour return line pressure gauge to confirm the flow and to avoid pulling a vacuum that may implode the vessel.
12. The unloading operation should be monitored closely by plant operators all the time.
13. When the vessel is empty, shut off the pump and close all liquid and vapour valves.
14. Drain and disconnect the hoses and fix the caps.

15. Leave the labels in place (according to the ADR/RID or IMDG guidelines).
16. Disconnect the earthing cables and remove the wheel chocks.
17. Verify that the vessel is empty.
18. The unloading hose should be emptied. If water is used for cleaning the unloading hose and pipeline system it is essential to make sure that a sufficient amount of water is being used. If the unloading hose and pipeline system are blown empty lean air must be used - please refer to page 11 Inhibitor Deactivation/Oxygen Depletion causing a polymerisation for background information. Alternatives to this procedure are to use either dry disconnect couplings or to employ a vacuum clean out system. The vacuum clean out takes place prior to disconnecting the hoses and efficiently minimizes emissions.

Unloading Rail Cars (RTCs)

The suggested unloading procedure is by pumping with a closed loop (vapour balance) system in which the vapours are returned to the vessel, or sending the vapours to a scrubber or incinerator. Railcars should preferably be equipped with an auto vent valve system that opens the vapour return valve prior to the bottom valve. This prevents implosion of the RTC in case that the vapour return line is blocked (polymer etc.). Please refer to the Cefic/ECTA/EPCA publication "Standard Rail Tank Cars for the carriage of liquid chemicals in bulk: Requirements for design, construction and testing".

1. Spot the rail car and set wheel chocks.
2. Positively identify Acrylic Esters. Before unloading, inspect the rail car to ensure that it is not damaged or leaking. Compare the labels and the rail car identification number to ensure that they are identical to the transport documents.
3. The rail car must be properly grounded before proceeding with any other operation.
4. Check that the vessel inventory is less than 35 °C before unloading.
5. If the temperature of the Acrylic Esters is confirmed to be above 35 °C immediately contact your supplier.
6. If the temperature of the Acrylic Esters is above 30 °C immediately contact your supplier.
7. Verify that the receiving vessel will hold the entire contents of the rail car.
8. Connect the vapour hose and open the valves to equalize pressure (not for auto vent valves).
9. Remove the protection cap of the coupling.
10. Ensure that the unloading liquid line is connected to the Acrylic Esters storage.
11. Connect the liquid line and open the external valve (for auto vent valve systems please follow the instructions on the RTC).
12. Open the internal valve.
13. Start the pump. Once the flow has started, continue to monitor the vapour return line pressure gauge to confirm the flow and to avoid pulling a vacuum that may implode the rail car (not required for auto vent valve systems).
14. When the rail car is empty, shut off the pump and close all liquid and vapour valves.
15. Drain and disconnect the hoses and fix the caps.
16. Leave the labels in place (according to the RID guidelines).
17. Disconnect the earthing cables and remove the wheel chocks.
18. Verify that the rail car is empty.

Unloading Vessels with Pressure

Vessels must not be unloaded by nitrogen pressure. It is not recommended to unload vessels by using pressurised gas. Your supplier should be contacted before this procedure is used.

7.4 Drums and Intermediate Bulk Containers

The use of drums or intermediate bulk containers (IBCs) for the transport of Acrylic monomers is authorized by the ADR/RID/IMDG regulations. The use of electrostatically safe drums and IBCs for loading and unloading is required by the UN Transport of Dangerous Goods "Orange Book" for substances with a flash point below 60°C (Volume II, Sec. 4.1.2 of the "Orange Book"). CENELEC report, R044-001, dated February 1999, provides guidance and recommendations for the avoidance of hazards due to static electricity.

Even though there is a range of allowable options in IBC selection, the following factors are important in drum and IBC selection: flammability, permeability of the packaging material to Acrylic Esters, UV exposure, temperature exposure, mechanical strength vs. temperature, impact resistance, proximity of use to other containers containing materials of different flash points, and odour control. There is a variety of ways to manage these factors by container selection and by organisational means.

From a technical perspective the following container selections fit best the listed monomer products, linked to their specific properties.

| Generic name: | Methyl acrylate | Ethyl acrylate | n-Butyl acrylate | 2-Ethylhexyl acrylate |
|------------------------------------|--------------------------------------------------|--------------------------------------------------|------------------------------------|----------------------------------------------------------|
| IBC Type: | Stainless Steel | Stainless Steel | Stainless Steel | Composite Plastic (non-transparent to UV-light at least) |
| Key Characteristics for Selection: | odour control, acrylate permeation, flammability | odour control, acrylate permeation, flammability | odour control, acrylate permeation | UV-light protection |

Table 7.1: Recommended IBC selection for Acrylic Esters

Drums made out of steel with an epoxy-phenolic internal coating are suitable for all Acrylic Esters. Drums made solely out of carbon steel may affect the product quality. Drums and IBCs should be labeled properly (See section 2.1, Classification according to EU directive 1272/2008, page 3).

7.4.1 Information for the Haulier

Avoid sources of heat, sparks, or open flames. Acrylic Esters should be shipped at temperatures below 35 °C.

Bulging or leaking IBCs or drums with blistered paint may indicate polymerisation and should not be transported..



Please note

If polymerisation is suspected, immediately contact the supplier.

Also see chapter 4, Instability and Reactivity Hazards, page 9 and chapter 9, Emergency Response in Case of Polymerisation and Fire, page 35 for more details.

When a load of drums/IBCs is received, open the doors of the truck carefully before entering. If a strong odour is present, indicating a leaking container, immediately call the supplier.

7.4.2 Storage of Drums and Intermediate Bulk Containers

Acrylic Esters are normally inhibited with 10 to 20 ppm of MeHQ to prevent polymerisation. The three most important considerations in shipping and handling Acrylic Esters are to:

 **Please note**

The three most important considerations in shipping and handling Acrylic Esters are:

- to avoid exposure to elevated temperatures,
- to avoid contamination,
- to use an oxygen containing blanket gas.

Acrylic Esters should be kept below 35 °C. Do not store in direct sunlight. A path of 1,5 meters should be kept free around each block of drums/IBCs, to provide ventilation and both normal and emergency response access.

Contamination can cause an uncontrolled polymerisation which may result in violent rupture of the container, fire, serious damage to the surroundings and significant environmental impact.

The presence of oxygen is required for the inhibitor (MeHQ) to be effective. Lack of oxygen can cause an uncontrolled polymerisation.

Reuse drums or IBCs only if thoroughly cleaned or in dedicated service.

Steel drums with liners should be inspected periodically. Penetration of the liner or permeation of Acrylic Esters through the liner may cause polymerisation.

Please see chapter 4 , page 9 for additional information on Instability and Reactivity Hazards.

7.4.3 Emptying of Drums and Intermediate Bulk Containers

Acrylic Esters mostly are flammable liquids and should be handled accordingly. The contents of the drums and IBCs should be *positively identified before* they are transferred and used. The following steps outline procedures for safely emptying drums and IBCs:

1. Drums and IBCs must be electrically grounded before starting and during the entire operation. A static-free dip pipe or flexible stainless steel hose should be used to drain the Acrylic Ester. If not designed to be electrostatically dissipative composite plastic drums or IBCs have to be placed into an earthed housing (designed according to CENELEC guidelines) prior to starting the decanting operation.
2. Drums/IBCs and fittings should never be struck with tools or other objects which may cause sparks or puncture.
3. Before removing plugs from Acrylic Ester drums or IBCs, locate the nearest emergency safety shower and eye wash station and put on personal protective equipment.
4. The preferred safe method for emptying drums and IBCs is by pumping. If drums or IBCs are emptied by gravity, the valves should be self-closing. Do not use pressure to displace drums or IBCs' contents.
5. Provide adequate vacuum breaking to prevent collapse of the drums or IBCs during emptying.

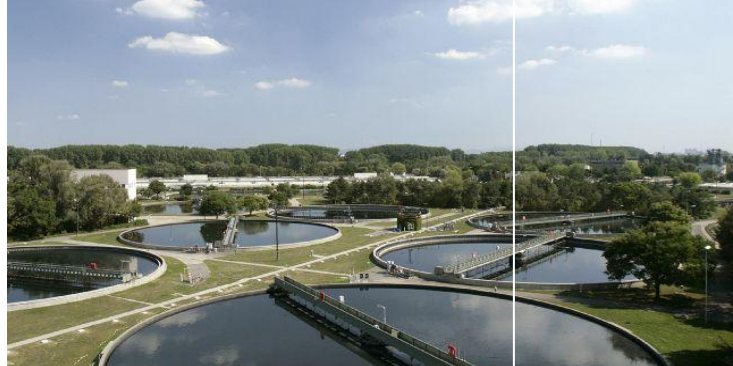

8 Environmental Considerations

8.1 Waste Disposal

State laws and local regulations governing waste disposal make it essential for producers, suppliers, hauliers and users of Acrylic Esters to be fully aware of viable options for the ultimate disposal of materials containing Acrylic Esters. Materials to be disposed of may be residues from production or cleaning operations, empty drums or IBCs as well as waste material from spills.

Acrylic Esters has been described in chapter 5, page 15 as materials that may cause skin irritation and sensitisation and eye damage. Accordingly, they should always be handled with all appropriate safety equipment.

If a biological treatment plant is available, minor amounts of monomers may be sparingly diluted with water and allowed to enter the treatment system after notification of the person in charge. The biodegradability of the material in diluted form is good. Please refer to the SDS. Acrylic Esters may however be toxic to the system if the bacteria have not been conditioned properly to this material. Accordingly, the initial feed rate should be low with a stepwise increase if a significant amount is to be fed into the biological treatment purification. Due to the low odour threshold of most acrylic monomers, sending material to an open waste treatment system may cause odour problems. As Acrylic Esters are harmful to aquatic life, biological treatment is necessary and spillages into surface waters and public sewers must be avoided.

Solid and liquid waste materials containing Acrylic Esters should be disposed of by incineration. Disposal in landfills must be thoroughly checked with the local authorities.

For disposing of waste materials originating from a laboratory or for retained samples, great care must be exercised to keep the monomer separated from incompatible materials (see Appendix 11.1, page 47), e.g. peroxides which may initiate polymerisation.

8.2 Spill and Leak Control

Small spills, up to 5 litres, can suitably be absorbed in commercially available clean-up-kits (infusorial earth). It is recommended to add solid PTZ to the contaminated clean-up material to avoid polymerisation and hence heat-up of the clean-up material.

If a waste water sewer is close by, the spill can also be washed down with water, provided it is not a storm-sewer or ditch which is routed to surface waters.

Large spills should be contained, if possible, within a diked area. The spill area after being confined may be covered by fire fighting foam. The foam helps to blanket the acrylate, prevents the escape of vapours and subsequent potential ignition. A temporary dike can be arranged by stacking sand bags or similar devices. Avoid run-off into storm sewers routed to public waters. If possible, the material should be recovered in appropriate containers for reuse or disposed of, using explosion proof equipment. During all handling operations of large spills, a chemical suit with self-contained or air-supplied breathing device must be worn. In the event of accidental spillage of Acrylic Esters to surface water or to a municipal sewer system, the pollution control agencies must be promptly notified.

8.3 Air Emissions

Discharges of Acrylic Ester vapours into the atmosphere are subject to restrictions in Europe, and must therefore be avoided using closed systems (e.g. dry disconnects, closed sampling systems) or be disposed of in conformity with air pollution control regulations. The best way to

avoid emissions is to eliminate those resulting from displaced gases from loading and unloading operations. In most cases this can be accomplished by back venting through a vapour return line. It should be considered good manufacturing practice in all storage facilities and (un-)loading installations. In order to properly use this system, the vent system must be dedicated to avoid the contamination of Acrylic Esters.

Exhaust gases loaded with Acrylic Esters originating from production should be cleaned prior to being emitted into the atmosphere. The exhaust gas can be treated via:

- Thermal Combustion Unit, e.g. a flare.
- Catalytic Conversion Unit.
- Caustic scrubber.

A low cost option is a purification tower (scrubber) operated with alkaline absorbant. Absorption is dramatically enhanced by the addition of non-volatile amines. The amine quickly reacts in a Michael addition reaction with the acrylic ester. This adduct subsequently will be saponified by the hydroxide. Isopropyl alcohol may be added as a co-solvent to increase the solubility of less soluble acrylic esters in the aqueous solution. An example is 20 percent sodium hydroxide, 10 percent diethanolamine, 6 percent isopropyl alcohol, and balance water. A straight aqueous sodium hydroxide solution can also be used but more residence time and higher reaction and lower absorption temperatures may be necessary to achieve comparable results. Depleted or spent scrubber solution can be drained into a biological treatment plant or incinerated, if permitted. Recycling the alkali acrylate in a production process should also be considered as an option. An approved design example with a corresponding drawing is suggested in section 10.3, page 44. The dimensional design for an appropriate tower depends on the flow rate of the gas.



Please note

Active carbon cartridges must never be used for the removal of acrylic esters from exhaust gases, unless the gases are pre-treated, e.g., in a wet scrubber.

- The heat of adsorption on active carbon is unusually high for all acrylic esters. Therefore, if highly loaded exhaust gases come into contact with active carbon, ignition is likely to occur .
- For the prevention of a back flash into the tank, carbon cartridges must always be isolated from the scrubber and the bulk storage tank by a flame suppression system (i.e., detonation arrestor).

8.4 Cleaning of Transport Vessels (Road Tankers/RTCs/IBCs)

8.4.1 Cleaning of Road Tanker / Isocontainers and Rail Tank Cars

Road tankers in dedicated service for Acrylic Esters may develop a gradual growth of polymer on walls and armatures. Cleaning on a regular basis of 6 months is suggested. If polymer has formed, it may possibly act as a seed for further polymerisation. Polymer particles may also adversely affect the quality. It is therefore recommended to periodically clean containers thoroughly. The most effective way is to blast the interior of the tank with high pressure water, first cold and then hot - in order to reduce odour issues. The off-gases during the cleaning process should be vented through a scrubber or incinerated.

Cleaning has to be carried out in cleaning stations recommended by the European Federation of Tank Cleaning Organizations (EFTCO) and certified by the SQAS standard. A European Cleaning Certificate from these cleaning stations is mandatory. If the previous cargo is an incompatible (see Appendix 11.1, page 47) then this vessel is not acceptable even after cleaning.

8.4.2 Cleaning of used drums or IBCs

Material remaining in drums is a potential threat to the health of humans handling the drums afterwards. It should be considered as a rule of good housekeeping practice to thoroughly rinse, wash and dry emptied drums prior to being reused or discarded.



9 Emergency Response in Case of Polymerisation and Fire

Signs that indicate an emergency:

- increased temperatures of the Acrylic Esters (due to external heating or an exothermal polymerisation).
- venting of the container.
- container deformation.

If there is an emergency during transport or in a user's storage tank immediately call your supplier (see section 7.2, page 27) and facilitate the establishment of communications between the personnel at the emergency site and the supplier's emergency response team.

Users of Acrylic Esters should develop site- specific written emergency plans for Acrylic Esters spills, fires, exothermal and incipient polymerisations.

These plans should focus on:

- Clearly identifying the features that categorize an event as an emergency.
- What should be done to secure the emergency site and immediate actions to mitigate the danger?
- A very important feature of the plan should be early notification of the incident so that the supplier can quickly provide expertise in helping to manage the incident.

9.1 Detection and Response to Incipient Polymerisation in a Storage Tank

If a system is installed and operated with all of the prevention measures recommended in this brochure and required by prudent engineering practice, the chances of experiencing an inadvertent polymerisation are minimized. However, in the case of unforeseen events which might lead to incipient polymerisation in a storage tank, it is necessary to detect such an event in a timely manner to avoid, stop or mitigate polymerisation. An option to provide additional protection from these unforeseen events is the use of a restabilisation (shortstop) system. This subsection deals with the operation of such an optional restabilisation system.

Credible Initiation Scenarios:

- External heating of Acrylic Esters (Please refer to subsection 4.1.1, Overheating causing a polymerisation, page 10 and subsection 6.1.1, Detection of Critical Conditions inside Bulk Storage Tanks, page 21 and subsection 6.1.2, Temperature Control of Bulk Storage Tanks and Accessories, page 22 and subsection 6.1.4, Pumps and Protection of Pumps from Overheating, page 23 and section 9.3, Fires, page 38).
- Removal of the dissolved oxygen from the monomer: If the monomer is purged with an inert gas (e.g. nitrogen or carbon dioxide) and the dissolved oxygen is removed, the MeHQ inhibitor becomes ineffective and polymerisation will ultimately occur. The length of the induction period until polymerisation occurs and the maximum rate of polymerisation are unpredictable because they depend on the previous storage history of the Acrylic Esters. If inert purging is known to have occurred, the Acrylic Esters should be sparged with a gas containing 5 to 21 Vol.-% of oxygen as soon as possible. Air is preferred (Please refer to subsection 4.1.5, page 11).

- Chemical contamination: The scope of a contamination scenario is very difficult to pre-define since the identity and concentration of the contaminant is unpredictable. However, it is recommended that the restabilisation (shortstop) system be immediately activated if contamination with a known or potential polymerisation initiator has taken place. If such contamination has occurred without the knowledge of responsible personnel, the restabilisation (shortstop) system should ultimately be activated in the event of an exothermal polymerisation (Please refer to subsection 4.1.3, page 10,).

9.1.1 Polymerisation Detection

The most reliable way to detect the approach of a runaway polymerisation is by redundant temperature monitoring and recording of the tank contents. This is best done by comparison of the actual temperature to the target storage temperature range, max. 35 °C. Acrylic Ester polymerisation is a highly exothermic reaction (It releases energy that results in heating of the liquid in the storage tank). A temperature monitoring system should be designed as per requirements of subsection 6.1.1, Detection of Critical Conditions inside Bulk Storage Tanks.

The polymer test described in subsection 4.1.7, Polymerisation Detection, page 12 is of a qualitative nature. The absence of turbidity in this test should not be interpreted as meaning that there is no polymerisation reaction going on.



Attention

even slow polymerisation has the potential to accelerate into a runaway reaction. If the temperature rises above 45 °C or the rate of rise is greater than 2 °C per hour, and no source of external heat has been identified, this should be considered as the onset of polymerisation. If the temperature rises at a rate greater than 5 °C per hour or the temperature reaches 50 °C, the situation is critical.

9.1.2 Restabilisation (Shortstopping)

Successful restabilisation of Acrylic Esters requires a timely response to detection of a significant temperature increase. The lack of a timely response may result in the onset of polymerisation leading to accelerated temperature and pressure rises. Therefore the activation criteria given in section 9.1.2 were developed. Concepts how to introduce the restabilisation inhibitor into the storage tank in a safe way have been developed (please refer to section 10.4, page 45). Due to the large number of possible contaminants and concentrations of those contaminants, these criteria may not apply if the cause of the inadvertent polymerisation is contamination.

Restabilisation (Shortstop) Inhibitor

Phenothiazine (PTZ) in solution is the preferred shortstop agent. While addition of PTZ has worked in most cases, there is no assurance that it will always be effective. Obvious exceptions are contamination of Acrylic Esters with gross amounts of a polymerisation initiator or a delay in activation of the shortstop system.

As PTZ is a solid it should be added as a solution to ensure easier addition and mixing. Commercial solutions are available (Trade names are for example Allesan Protacryl® and RESTAB™). Please consult your supplier for details.

Restabilisation (Shortstop) Inhibitor Solution

Unfortunately, the solubility of PTZ in Acrylic Esters is only about 2 wt.-% at ambient temperature. The PTZ shortstop solution should be as highly concentrated as possible to minimise its volume, so that it can be pumped in as quickly as possible. Known solvents include N-Methylpyrrolidone, Tripropylene glycol, Glycol ethers and Dimethyl sulfoxide (DMSO). The final concentration of PTZ in the Acrylic Ester to be shortstopped is suggested to be in the range of 50 to 200 ppm. Commercial inhibitor solutions or even technical packages to apply the solution to a storage tank are available on the market. Please consult your supplier.

However, in the case of contamination, restabilisation may not be possible at any concentration of PTZ, depending on the nature and concentration of the contaminant.

Activation Criteria for Restabilisation (Shortstop) Systems

It is recommended to activate the restabilisation (shortstop) system immediately if any of the following criteria apply:

Please note

- A temperature increase of greater than 5 °C/h has been detected without external cause.
- The temperature in the liquid has reached 45 °C.
- There is a fire near an Acrylic Esters tank.
- A known polymerisation initiator or incompatible substance has been inadvertently added to the Acrylic Esters. (see Appendix 11.1, page 47)

The above criteria should provide adequate time for adding and dispersing the restabilisation solution to tank contents.

Any temperature or temperature rise that exceeds the possible rise from external heat sources (ambient, sun, pumps, temperature control systems, receipt of warmer product, etc.), may indicate an ongoing polymerisation. The lowest practical temperature or temperature rise should be used as a call for investigation. Manual activation of the shortstop system is preferred for sites with continuous manning; otherwise automatic activation of shortstop system should be used. In any case, the shortstop system should be activated if the criteria specified above are met. Methods how to do that safely have been developed (please refer to section 10.4, page 45).

Attention

Do not approach a tank whose contents have reached or exceeded 60 °C.

Mixing of Restabilisation (Shortstop) Inhibitor

It is possible to quickly bring the concentration of the shortstop inhibitor to effective levels by circulating the storage tank contents with a pump and / or by gas induced mixing. If a pump is used to mix shortstop solution, the interlock instrumentation must be designed to allow for this emergency procedure to be executed. The use of eductor tubes on the tank inlet(s) or a gas lift can reduce the time required to mix the shortstop solution with the tank contents.

The design and installation of the shortstop inhibitor system should be specific to the tank farm layout. Methods how to do that safely have been developed (please refer to section 10.4, page 45). Please clarify the above-mentioned issues by consulting your supplier.

The addition of large amounts of water should only be considered as a last resort if the addition of PTZ failed, since water and acrylic esters are not miscible resulting in phase separation. The water phase is heavier than the ester phase and will, therefore, cover the temperature sensors and delay detection of any temperature increase. In addition, the release of large volumes of steam and Acrylic Ester vapour, and the possibility of tank overflow detract from this option.

Restabilisation (Shortstop) of Road Tankers

Road Tankers arriving at the unloading site with elevated Acrylic Esters temperatures (higher than max. storage temperature of 35 °C) may require restabilisation. The first step is to verify the temperature as indicated in section 8.4, Cleaning of Transport Vessels (Road Tankers/RTCs/IBCs), page 34. If the temperature reading is confirmed to be high, Phenothiazine or phenothiazine solution should be added to the tank either via the vapour return, the manway or the bottom outlet. The tank content can be mixed by shortly driving and stopping the vehicle.

Attention

Do not approach a tank whose contents have reached or exceeded 50 °C. If you are not familiar with the emergency procedures for restabilisation do not approach at all a tank whose temperature reading is confirmed to be high.

9.2 Spills

Containment is the most important technique for handling spills. Numerous techniques can be used in containing spills (see also chapter 8, page 33):

- Acrylic Esters on the ground: diking, diverting and absorption;
- Acrylic Ester still leaking from a container: plugging, patching, repairing, and tightening of container fittings or secondary containment (drums).

If there is a waste water treatment plant capable of treating Acrylic Ester, small spills may be washed to the chemical waste treatment sewer with large amounts of water. Small spills of up to 5 liters can be absorbed using sand or infusorial earth.

Large spills should be contained, if possible, within a diked area. A temporary dike can be arranged by stacking sand bags or similar devices. Avoid run-off into storm sewers routed to public waters.

Wherever possible, the material should be recovered in appropriate containers for reuse or disposal. The Acrylic Ester is likely to be contaminated and therefore Phenothiazine should be added as a stabiliser (0,1 wt.-% is the minimum recommended amount).

However, if a waste water sewer is available, the remainders can also be sparingly washed down after dilution and neutralization prior to being discharged to a waste water treatment plant.

Attention

PPE must be worn when fighting larger spills
(see also section 5.5, page 19).

More information on environmental considerations with regard to spill prevention is given in section 8.2, Spill and Leak Control, page 33.

9.3 Fires

Most Acrylic Esters are flammable liquids. At recommended storage conditions (max. 35 °C there is still a significant fire risk for MA, EA and BA because the liquid's temperature is close to or above the flash point.

Attention

Avoid ignition sources such as static electricity, open flames, hot works on the tank, sparks etc.

2-EHA is not classified as a flammable liquid. Heat input from sun radiation may result in temperature layers. The temperature of the top liquid layer might be above the flash point for storage tanks or vessels where there is neither insulation nor circulation. In addition potentially explosive mists may be generated in case of spray or high velocity liquid jets discharged from a nozzle or pipeline. Flow or discharge velocities of more than 4 m/s from a line might generate static electricity. Ensure that there is proper grounding and electrical connectivity when transferring from one container to another. Fine mesh filters should be avoided or measures should be taken to allow for relaxation of electrostatic charges generated. Splashing into a tank can be avoided by using a dip tube. A spark discharge from static electricity or any other common ignition source may cause ignition. Further information on how to avoid issues with static electricity can be retrieved from CENELEC.

9.3.1 Firefighting Measures

Attention

PPE must be worn when fighting larger spills
(see also section 5.5, page 19).

Alcohol resistant foam should be used to fight a fire, since Acrylic Esters are not miscible with water. Water fog may be applied to remove the heat of the fire. Small fires can be fought with carbon dioxide or dry chemical extinguishers. For larger fires, foam can be used. In the event that the content of an Acrylic Ester tank has caught fire, a restabilisation agent should be added as quickly as possible as a first step.

Please note

Always add restabilisation agent as first step.

This will help to prevent a runaway polymerisation, assuming that this was not the cause of the fire. Please refer to section 9.1.2, Activation Criteria for Restabilisation (Shortstop) Systems , page 37.

Addition of water into a tank of burning Acrylic Esters could result in a pressure build-up if the temperature of the Acrylic Esters is above 100 °C. This is because the water could be rapidly vapourized, causing a significant pressure surge and massive venting of a mixture of steam containing Acrylic Esters vapour.

9.3.2 Fire adjacent to an Acrylic Esters Storage

Acrylic Esters are reactive substances which can polymerise if exposed to high temperatures (see chapter 4, Instability and Reactivity Hazards, page 9).

It is therefore essential that an emergency plan is developed which contains measures to closely monitor and record the temperature of Acrylic Ester storage tanks. In case of a fire in the vicinity of an Acrylic Ester tank or tank farm, the Acrylic Ester containing tank(s), pipes should be cooled by water spray. Local overheating could result in an inadvertent, violent and exothermal polymerisation evolving considerable heat and pressure and ejecting hot vapour and polymer.

A water spray or fog of 7 l/(min, m²) to tank or pipeline surfaces is usually sufficient to absorb heat and maintain a lower temperature.

Tank cooling and circulation by means of the external cooling system should be initiated to reduce the risk of local overheating of the tank contents. Incident commanders, fire fighters, and emergency response personnel must be trained on the polymerisation hazards of Acrylic Esters in order to determine the proper response in case of an emergency (Please refer to subsection 9.1.2, page 36 for further advice on restabilisation).

In the event of a fire affecting Acrylic Esters, it is necessary to evacuate all non-essential personnel when the liquid temperature reaches 50 °C, due to the risk of a runaway polymerisation.

At 45 °C latest a restabilisation agent should be added to the monomer to limit the risk of an inadvertent polymerisation.

Attention

At 60 °C all personnel should be evacuated.

After the fire, continue to monitor the temperature of the storage tank for at least 48 hours to verify that the temperature is not rising. Check that the tank is sufficiently stabilised (dissolved

oxygen, MeHQ content).

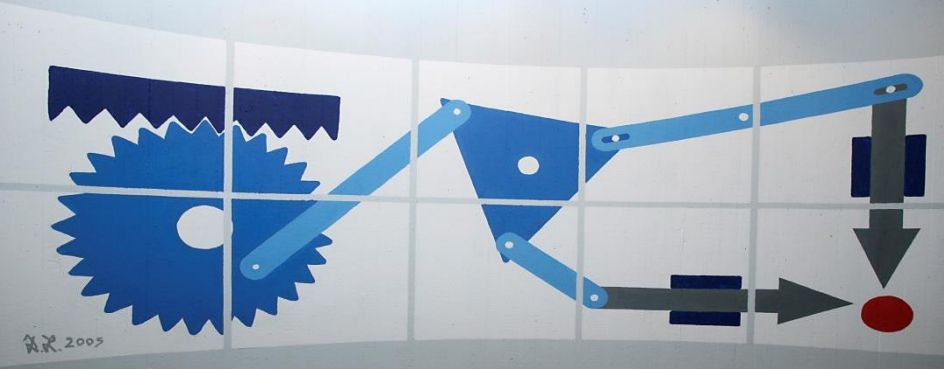

10 Design of Equipment for Acrylic Esters Service

10.1 Design Suggestion for a mixed gas (lean air) system

Please refer to subsection 6.2.2, page 24 and subsection 4.1.6, page 11 for background information.

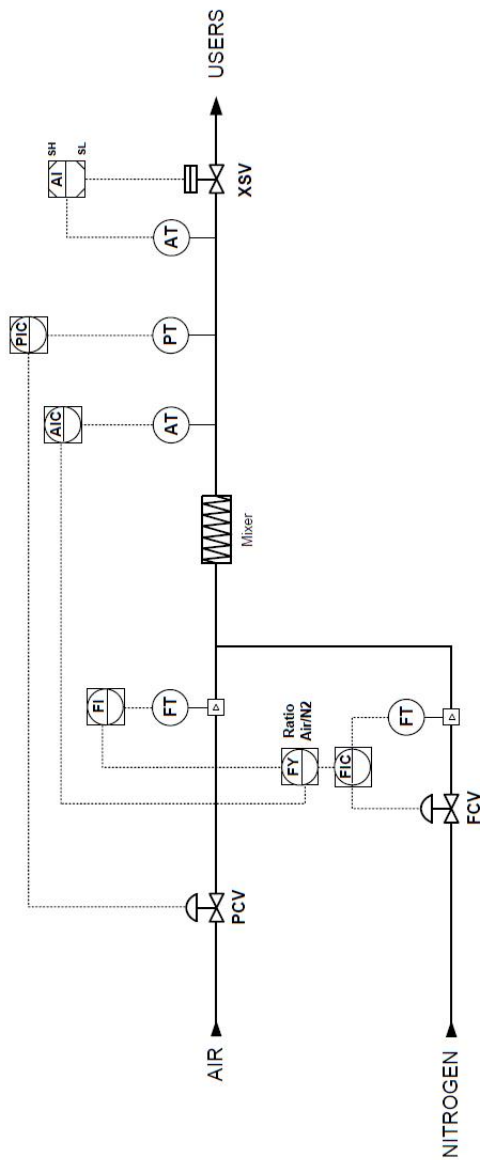

| Symbol | Definition | Symbol | Definition |
|--------|-------------------------------------------------------|---------------|--------------------------------------------------------------------|
| AIC: | Analyser, Indicator and Controller | AISH: /SL: | Analyser with Indicator and High as well as Low Interlock function |
| AT: | Analyzer Transmitter (for the O ₂ content) | FCV: | Flow Control Valve |
| FI: | Flow Indicator | FIC: | Flow Indicator and Controller |
| FT: | Flow Transmitter | FY: | DCS calculation block |
| PCV: | Pressure Control Valve | PIC: | Pressure Indicator and Controller |
| PT: | Pressure Transmitter | XSV: | Safety Valve |

10.2 Design Suggestions for an Acrylic Esters Tank

Schematic Design of an Acrylic Esters Storage Tank

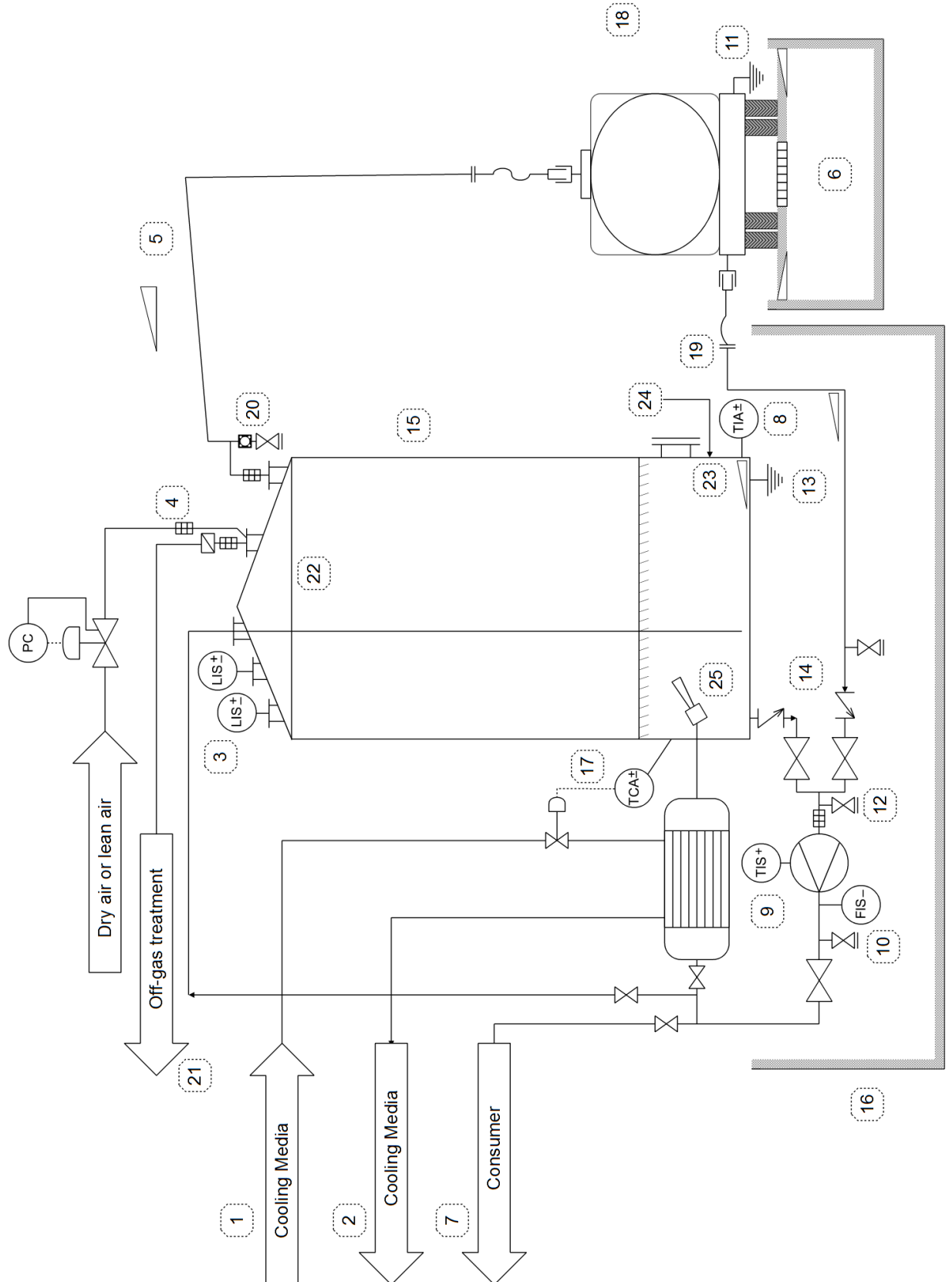

Description of suggested Acrylic Esters Tank design

| Mark | Definition | Mark | Definition |
|------|---------------------------------------------------------------------------------------------------------------------------------------------------------------------------------------------------------------------------------------------------------------------------------------------------------------------------------------------------------------|------|--------------------------------------------------------------------------------------------------------------------------------------------------------------------------------------------------------------------------------------------------------------------------------------------------------------------|
| 1 | Cooling media supply (depending on local ambient temperatures) | 2 | Cooling media return (see subsection 6.1.1.2, page 22). |
| 3 | Level indication with low/high alarm and low/high interlock and recording. Interlock high should shut down the unloading pump to avoid overflowing of tank. Interlock low should shut down the pump to avoid spray formation in the tank or dry running (see subsection 6.1.1.3, page 22). | 4 | Conservation valve to protect the tank shell in case pressure design characteristics are exceeded. The conservation valve is usually installed in combination with a flame / detonation arrester (see section 6.2, page 24). Flame arrestors must be periodically inspected for free passage (polymer formation!). |
| 5 | Vapor return line: The vapour return line minimizes emissions (see section 6.2, page 24).. For fire protections the line should be equipped with a flame / detonation arrester. The line has an inclination so that any condensed liquid is drained back. The flame arrester must be inspected for free passage (polymer formation!) prior to using the line. | 6 | Sump pit below truck unloading station for collection of spills. This pit should be separated from other pits which may contain incompatible materials. |
| 7 | Product off-take to consumption (application process). | 8 | Temperature indication with high alarm and reading (see subsection 6.1.1.1, page 21). |
| 9 | Temperature indication with high alarm and interlock at the product pump to protect pump from overheating and to avoid polymerisation (see subsection 6.1.4, page 23). | 10 | Flow indication with low alarm and interlock at discharge of product pump to protect pump from dry running and deadheading (overheating). |
| 11 | Earthing (grounding) of Isotainer. | 12 | Drain valves for pump and line system. |
| 13 | Earthing (grounding) of tank. | 14 | Check valve in unloading line to avoid backflow from tank into Isotainer. |
| 15 | Optional insulation of the whole storage tank. | 16 | Diked area around tank and pumping station to collect spills. |
| 17 | Temperature control with high alarm and reading (see subsection 6.1.1, page 21). | 18 | Safety and eye showers (not shown). |
| 19 | Unloading hose (dedicated see section 6.5, page 26). | 20 | Drain valve and sight glass. Empty out, if condensed material from vapour return line is visible. |
| 21 | Off-gas treatment (see section 6.2, page 24). | 22 | Weak-seam roof (see subsection 6.1.1, page 21). |
| 23 | Sloped tank floor for complete drainage. | 24 | Connection of restabilisation (see section 10.4, page 45). |
| 25 | Mixing nozzle and in case of low level dip tube recirculation (see subsection 6.1.3, page 22). | | |

10.3 Design Suggestions for a Scrubber

Simplified scheme for a scrubber see section 8.3, page 33

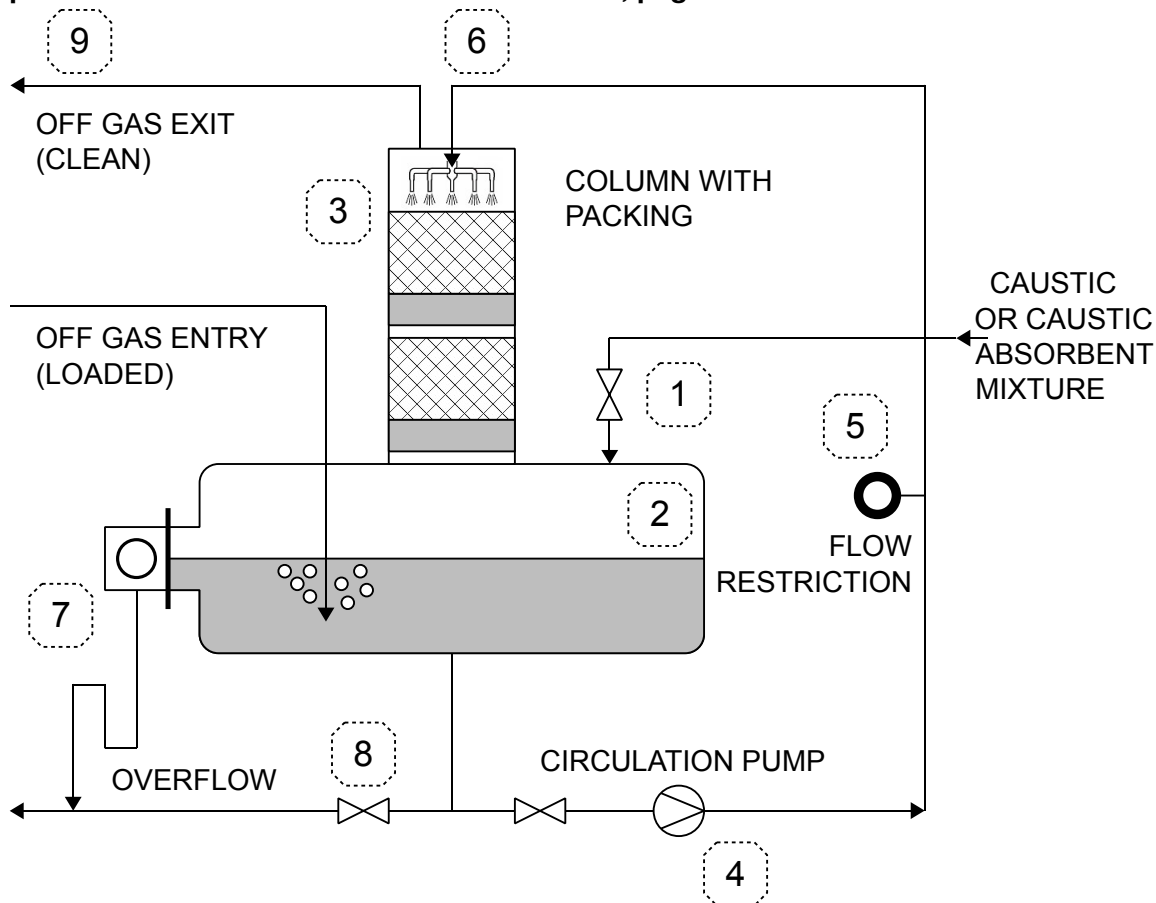

Description of suggested Off-Gas Purification design

Mark Definition

- ① The inlet valve is preferably designed for manual operation. Preferred absorbent liquids are caustic or a mixture of caustic and diethanolamine. When the caustic absorbent has been consumed (please monitor the pH of the absorbent liquid) it may be routed to a biological wastewater treatment.
- ② Suitable material for the container and the column is stainless steel.
- ③ For the random packing, Raschig rings or any other packing material may be used. The insertion of 2 distributor trays is recommendable. The packing may be stainless steel or plastic material. For stability reasons, trays should be made from stainless steel.
- ④ Recirculation pump according to design data.
- ⑤ Flow restriction for the absorbent in the bypass. If too much absorbent is fed into the column, the free gas flow is suppressed and pressure will build up. With insufficient feed of fluid the washing efficiency is unsatisfactory.
- ⑥ A conical nozzle uniformly distributes the absorbent on the packing. If the packing of the column is not uniform the gas escapes through a coherent channel and no washing is achieved.
- ⑦ Overflow into the sewer (only if routed into treatment plant).
- ⑧ Valve for complete drainage of the container.
- ⑨ Outlet for the purified exhaust gas.

The following layout data are suggested:

| | |
|-------------------------------------------------------------------|---------------------------------------------------------------------------------------------------------------------------------------------------------|
| Volume flow in [m ³ /h] of absorbent in recirculation: | 2-4% of gas volume flow V in [m ³ /h] |
| Diameter D [mm] of column: | 15 to 25 times the square root of the gas volume flow V in [m ³ /h], corresponding to a gas velocity of approximately of 0,5 to 1,5 [m/sec]. |
| Length L [mm] of column: | Approximately 10 to 20 times the diameter D [mm] |

10.4 Design Suggestions for the connection of a restabilisation system

The following 2 diagrams represent possibilities to inject the shortstop solution into the storage tank in case of emergency. Both systems are either designed or can be designed such that the mixing of the liquid phenothiazine (PTZ) solution is provided even if any other power fails, like e.g. any electrical power supply. However a redundancy in terms of power, local connection to a compressed air network etc. is acceptable to provide for the case of emergency.

10.4.1 Schematic Design of a tank installation using mobile RESTAB™ units

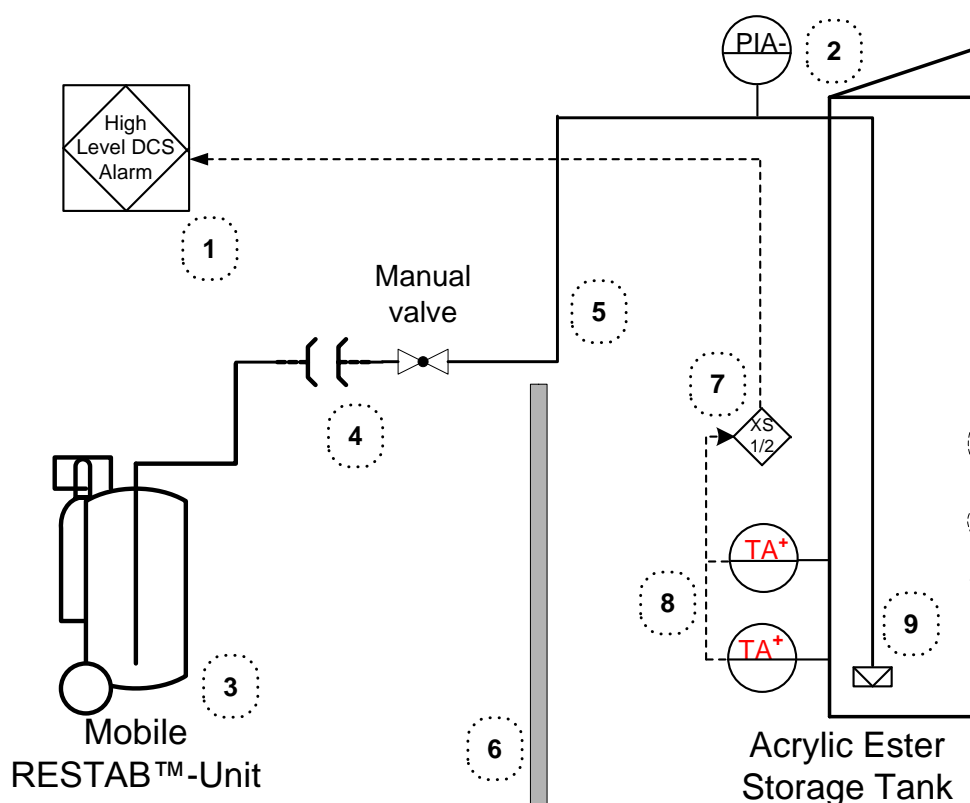

Mark Definition

- ① A "DCS alarm" that cannot simply be muted by a push button. The signal needs to be visible for all operating personnel as long as the alarm condition is in place. The control room has to be 24/7 manned.
- ② This pressure alarm is an indication whether the rupture disk is intact. The rupture disc keeps the monomer out of the pipeline to make sure that no polymer is blocking the pipeline.
- ③ Mobile RESTAB™-Units are commercially available. Please search on the Internet for suppliers. A mobile unit can be used for different tanks. The feed pipeline has to be dedicated.
- ④ The mobile unit is connected via a dry disconnect coupling. Only after the valves at the RESTAB™-Unit have been opened the manual valve is opened.
- ⑤ Dedicated pipeline for the restabilisation liquid designed such that the pressurized gas will convey the liquid completely especially through the vertical sections of the pipeline.
- ⑥ A Fireproof Wall at bunded area or a place distant to it where the connection of the mobile unit can be made safely even if a fire is inside the bunded area of the storage tanks.
- ⑦ For safety purposes a "1 out 2" selection is used to initiate the alarm. A "1 out n" alarm is suggested in case of a higher number of temperature probes in the storage tank.
- ⑧ Two independent temperature probes located such that they are always covered by liquid and as far apart as possible are installed.
- ⑨ Zero void volume rupture disk at the end of a dip tube. The construction should be such that the dip tube can be taken out and the rupture disk repaired without having to empty the tank. Alternatively the pipeline can be kept clear using a constant flow of air. In this case a low flow alarm instead of a low pressure alarm should be used.

10.4.2 Schematic Design of a fixed installation restabilization (shortstop) system

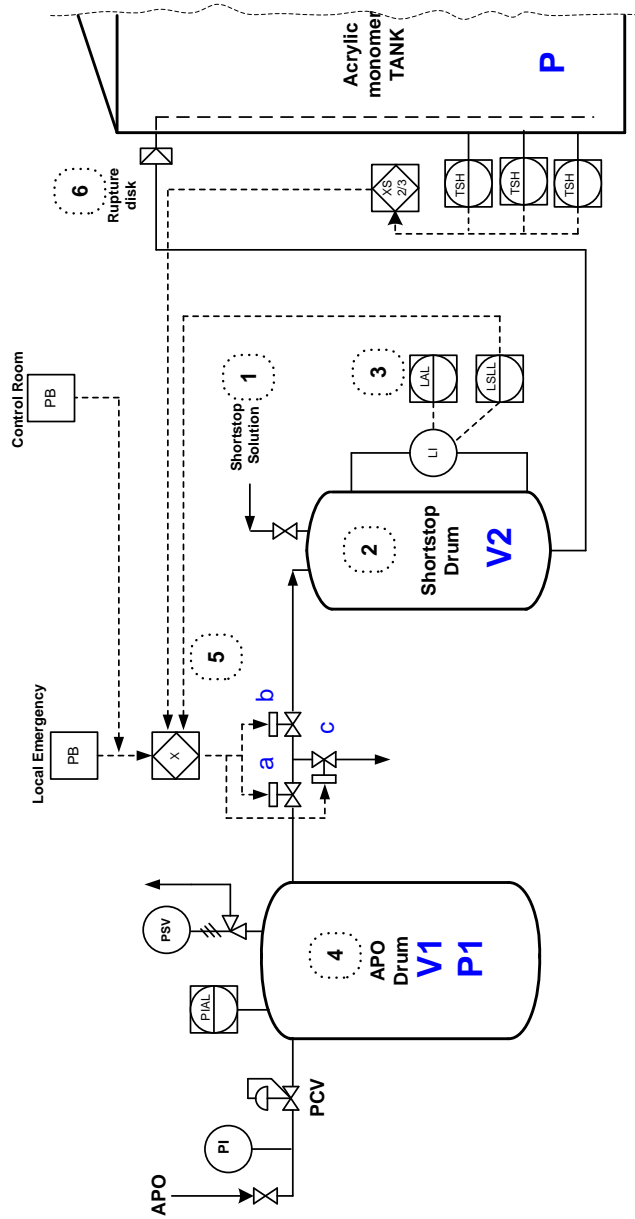

| Mark | Definition | Mark | Definition |
|------|---------------------------------------------------------------------------------------------------------------------------------------------------------------------------------------------------------------|------|--------------------------------------------------------------------------------------------------------------------------------------------------------|
| 1 | Filling or refilling of shortstop solution in the drum | 2 | Shortstop solution storage, capacity of volume V2, is adapted to the dilution level and to the Acrylic Ester storage tank size. |
| 3 | Level indication with low alarm and with LSHL reported in the control room. | 4 | Air or lean air pressure tank of volume V1 and pressure P1, used to flush shortstop solution into the Acrylic Ester storage tank of static pressure P. |
| 5 | Interlock sequence opening valves a and b, and closing valve c, in order to push shortstop solution. A manual valve can also be used provided it is located in a safe place distant enough from storage tank. | 6 | Rupture disk bursting under the pressure of shortstop solution going to the Acrylic Ester storage tank. |

11 Appendix

11.1 Incompatible Substances

Almost any contamination can potentially destabilize the monomer and should be avoided. The following is a partial list of chemicals which are considered to be incompatible with Acrylic Esters. In most cases, these contaminants cause polymerisation of the monomer.

1. peroxide or peroxy- in name
2. per in name, e.g. t-butylperacetate
3. peresters or peroxyesters
4. percarbonates or peroxyarbonates
5. hydroperoxide or hydroperoxy- in name
6. azo compounds
7. azides
8. ethers (if containing peroxide)
9. amines
10. conjugated polyunsaturated acids and esters
11. aldehydes and some ketones
12. reactive inorganic halides (e.g. thionyl chloride, sulfuryl chloride)
13. caustics (e.g., NaOH, KOH, Ca(OH)₂)
14. strong mineral acids (e.g., nitric, sulfuric, hydrochloric acids)
15. oxidizing agents (e.g., chromic acid, permanganates, nitric acid)
16. mercaptans
17. carboxylic acid anhydrides (rendering MeHQ inefficient)
18. inert gases (<5 Vol.-% oxygen)
19. certain transition metal ions (iron, ...)

11.2 Instructions in Writing According to ADR

Actions in the event of an accident or emergency

In the event of an accident or emergency that may occur or arise during carriage, the members of the vehicle crew should take the following actions where safe and practicable to do so:

- Apply the braking system, stop the engine and isolate the battery by activating the master switch where available;
- Avoid sources of ignition; in particular, do not smoke or switch on any electrical equipment;
- Inform the appropriate emergency services, giving as much information about the incident or accident and substances involved as possible;
- Put on the warning vest and place the self-standing warning signs as appropriate;
- Keep the transport documents readily available for responders on arrival;
- Do not walk into or touch spilled substances and avoid inhalation of fumes, smoke, dusts and vapours by staying up-wind;
- Where appropriate and safe to do so, use the fire extinguishers to put out small/initial fires in tyres, brakes and engine compartments;
- Fires in load compartments should not be tackled by members of the vehicle crew;
- Where appropriate and safe to do so, use on-board equipment to prevent leakages into the aquatic environment or the sewage system and to contain spillages;
- Move away from the vicinity of the accident or emergency, advise other persons to move away and follow the advice of the emergency services;
- Remove any contaminated clothing and used contaminated protective equipment and dispose of it safely.

For the labelling please refer to ADR as published under:

http://www.unece.org/trans/danger/publi/adr/adr_linguistic_e.htm

11.3 Index of Abbreviations

| | |
|---------|-------------------------------------------------------------------------------------------------------------------------------------------------------------------|
| 2-EHA | 2-Ethylhexyl acrylate |
| AA | Acrylic Acid |
| ADR | Accord européen relatif au transport des marchandises dangereuses par route. European agreement concerning the international carriage of dangerous goods by road. |
| BA | n-Butyl acrylate |
| BAMM | Basic Acrylic Monomer Manufacturers Inc. |
| BLEVE | Boiling Liquid Expanding Vapor Explosion |
| BS | British Standard |
| Butyl | Isobutylene-Isoprene-Rubber |
| CAS | Chemical Abstract System |
| Cefic | Conseil Européen de L'Industrie Chimique |
| CENELEC | Comité Européen de Normalisation Electrotechnique |
| CLP | EU Regulation on Classification, Labelling and Packaging of substances and mixtures |
| CR | Chloroprene Rubber |
| DCS | Digital Control System, better known as Process Control System |
| DIN | German Industry Standard (Deutsche Industrie Norm) |
| EA | Ethyl acrylate |
| EBAM | European Basic Acrylic Monomer |
| EC | European Commission |
| EC | effect concentration |
| EC50 | effect concentration 50 % |

| | |
|----------|-----------------------------------------------------------------------------------------------------------------------------------------------------------------------------|
| ECHA | European Chemical Agency |
| ECTA | European Chemical Transport Association |
| EFTCO | European Federation of Tank Cleaning Organizations |
| EINECS | European Inventory of Existing Commercial Chemical Substances |
| EN | European norm |
| EPCA | European Petrochemical Association |
| EPDM | Ethylene propylene diene monomer |
| EU | European Union |
| EVOH | Ethylene Vinyl Alcohol Polymer |
| FKM | Fluorkautschuk auf Polymethylenbasis |
| GHS | Globally Harmonised System |
| GLP | Good Laboratory Practice |
| HAZOP | Hazard and Operability |
| IARC | International Agency for Research on Cancer |
| IBC | Intermediate Bulk Container |
| IBC Code | International code for the construction and equipment of ships carrying dangerous chemicals in bulk |
| ICE | Intervention in Chemical Transport Emergencies |
| IEC | International Electrotechnical Commission |
| IMDG | Code International Maritime(IMO) Dangerous Goods Code |
| IMO | International Maritime Organization |
| ISO | International Standard Organization |
| IUCLID | International Uniform Chemical Information Database |
| LC50 | Lethal Concentration (50%) |
| LD50 | Lethal Dosis (50%) |
| LEL | Lower Explosion Limit |
| LG | Liquified Gas |
| LOC | Limiting Oxygen Concentration |
| LSLL | A low Level interlock that will then stop the flow of lean air from the lean air buffer drum |
| MA | Methyl acrylate |
| MAC | Maximum Acceptable Concentration |
| MARPOL | International Convention for the Prevention of <u>M</u> ARine <u>P</u> OLLution from Ships |
| MeHQ | Monomethyl ether of hydroquinone |
| mSv | milli Sievert (unit for radiation) |
| NBR | Acrylonitrile-Butadiene-Rubber |
| NEC | National Electrical Code (United States) |
| NFPA | National Fire Protection Association (United States) |
| NOEC | no observed effect concentration |
| NTP | National Toxicology Program |
| OECD | Organization for Economic Corporation and Development |
| OEL | Occupational Exposure Limit |
| PC-valve | Pressure control valve |
| PE | Polyethylene |
| PPE | Personal Protective Equipment |
| PRV | Pressure relief valve, sometimes used for a conservation valve combination as well |
| PTFE | Polytetrafluorethylene |
| PTZ | Phenothiazine |
| PVA | Polyvinyl Alcohol |
| PVC | Polyvinyl Chloride |
| REACH | Registration Evaluation Authorization of Chemicals (European Chemicals Legislation) |
| RESTAB™ | Mobile restabilisation unit - commercially available |
| RID | Règlement International concernant le transport de marchandises dangereuses par chemin de fer. Regulations concerning the international carriage of dangerous goods by rail |
| RTC | Rail Tank Car |
| SIL | Safety Interlock Level |
| SQAS | Safety and Quality Assessment System (Cefic) |
| SDS | Safety Data Sheet or extended Safety Data Sheet |

| | |
|------|--------------------------------------------------------------------------------------------|
| STEL | Short Term Exposure Limit |
| STOT | Specific Target Organ Toxicity |
| TLV | Threshold Limit Value |
| TWA | Time Weighted Average |
| UEL | Upper Explosion Limit |
| UN | United Nations |
| UV | Ultra Violet (part of the invisible light spectrum) |
| VbF | Verordnung über brennbare Flüssigkeiten (The german ordinance governing flammable liquids) |
| VDE | Verband Deutscher Elektrotechniker (association of german electronic engineers) |

Index

Index of keywords for Acrylic Ester Safe Handling and Storage

- A**
air 9, 23
- C**
contamination 9f., 23, 26f., 32, 36, 47
corrosion 9, 11
- D**
dissolved oxygen 9, 11, 22, 24, 27, 35
drums and IBCs 10, 26, 31
- E**
electrical 48
emergency 21, 24, 26, 35, 37, 48
emergency phone numbers 28
emergency response 28, 32, 35
emission 24, 34, 43
- F**
fire 22, 24f., 27, 32, 35, 37f., 45, 48
flame arrestor 11, 24, 43
flammability 1, 4, 11, 13, 21, 24f., 28, 31f., 38
flash point 13, 23ff., 31, 38
- G**
glove 5, 19
- H**
hazard 1, 9, 27f., 31, 39, 49
- I**
ignition 23, 25, 34
inhibitor 9, 11, 24, 27, 35f.
initiator 10, 26f., 36f., 47
- L**
lean air 11, 24, 30, 41
- M**
manufacturer 1, 28
MeHQ 1, 9, 11, 24, 35, 47
mixing 10, 22f., 36f.
mixing *see also* dissolved oxygen 43
- N**
nitrogen 27, 30, 35
nozzle 22, 25f., 38, 43
nozzle *see also* static electricity 22
- O**
odour 7, 18, 31, 33f.
overheating 9f., 23, 43
oxygen *see also* dissolved oxygen 9
- P**
polymer 10, 12, 22ff., 26, 34, 36, 43, 45
polymerisation 9, 21–24, 31, 33, 35, 47
PTZ 33, 36, 45, 49
- R**
radiation 10, 38
restabilisation 24, 35ff., 39, 43
rupture disk 45f.
rupture disk *see also* weak seam roof 22
- S**
scrubber 24, 29f., 34, 44
spill 23, 25, 29, 33, 35, 38, 43, 48
static electricity 22, 25, 31f., 38
steel 11, 26, 31, 44
storage tank 9ff., 21f., 24ff., 29, 35f., 39, 42, 45
- T**
tank 21, 24, 28, 30, 34, 37
tank *other than* storage tank 27
temperature 10f., 21f., 30f., 37ff.
- U**
UV-light 10, 31
- V**
vapour 4, 12f., 15, 20f., 24, 26, 33
vapour return 24f., 29, 34, 43
vent 5, 9, 11f., 24, 30, 34, 43
- W**
waste 33, 44
water 18, 30, 39
weak seam roof 22, 24, 43
- X**
X-ray 10
X-ray *see also* radiation 9

Cefic - The European Chemical Industry Council

Chemistry making a world of difference



Cefic
Avenue E. van Nieuwenhuyse 4
B - 1160 Brussels
tel +32 2 676 72 11
fax +32 2 676 73 00
mail@cefic.be
www.cefic.org